

## Aerosol Route to Antibacterial Nanosilver Coating of Cotton Fabrics

E. Hontañón<sup>1,\*</sup>, J. Feng<sup>2</sup>, M. Blanes<sup>3</sup>, X. Guo<sup>4</sup>, L. Santos<sup>5</sup>, A. Schmidt-Ott<sup>2</sup>, H. Nirschl<sup>4</sup>, F.E. Kruis<sup>1</sup>

<sup>1</sup> *Institute of Technology for Nanostructures and Center for Nanointegration Duisburg-Essen, CENIDE, University of Duisburg-Essen, Bismarckstr. 81, 47057 Duisburg, Germany*

<sup>2</sup> *Department of Chemical Engineering, Delft University of Technology Julianalaan 136, 2628 BL Delft, The Netherlands*

<sup>3</sup> *Department of Technical Finishing and Comfort, AITEX, Plaza Emilio Sala 1, 03801 Alcoy, Spain*

<sup>4</sup> *Institute for Mechanical Process Engineering and Mechanics, Karlsruhe Institute of Technology, KIT, Straße am Forum 8, 76131 Karlsruhe, Germany*

<sup>5</sup> *Foundation for the Promotion of the Textile Industry (FOMENTEX), Els Telers 20, 46870 Ontinyent, Spain*

(Received 15 July 2014; published online 29 August 2014)

The paper describes a gas phase process for the preparation of cotton fabrics coated with silver nanoparticles as antimicrobial agents. Silver nanoparticles are synthesized by means of atmospheric pressure electrical discharges (spark discharge and glow discharge) in pure inert gases, and the aerosols are passed through cotton fabric samples, where nanoparticles deposit. The particle size distribution of the aerosols is measured online during synthesis. Also, the crystallinity, size and morphology of the silver particles are analyzed. The mean size of the primary particles of silver varies from 4 nm to 18 nm, depending upon the type of discharge, the nature and flow rate of the gas. The bactericidal activity of the cotton samples doped with silver nanoparticles is assessed following the ISO 20743 method. All cotton samples show significant bactericidal property, although it degrades with increasing primary particle size and particle agglomeration. This purely physical aerosol route is a promising sustainable method for nanocoating of textiles.

**Keywords:** Silver nanoparticles, Primary particle size, Filtration, Cotton fabrics, Bactericidal property

PACS numbers: 81.20.Rg, 61.05.cf, 68.37.Lp

### 1. INTRODUCTION

Silver nanoparticles with their unique chemical and physical properties are proving as an alternative for the development of antimicrobial agents for a variety of applications [1], among others, antibacterial textile fabrics [2]. In this regard, it has been reported that silver nanoparticle coated fabrics possess significant bactericidal property [3]. Nanosilver finishing of textile fabrics is commonly attempted by means of wet routes. Silver nanocolloids are prepared by reducing a silver salt in a solution by purely chemical process or assisted by irradiation with a light source (UV or laser) or by ultrasounds [4-5]. Also, surfactants and polymers are added to the solution for the stabilization of silver nanoparticles against agglomeration and for the control of nanoparticle size and shape [6-8]. Silver nanoparticles are then applied onto fabrics by using dip-pad-dry-cure methods. Nowadays, a growing need to develop eco-friendly processes is highlighted, which do not use toxic chemicals in the synthesis protocols and do not produce hazardous wastes [9]. This paper reports on a green aerosol process for nanosilver finishing of cotton fabrics. Silver nanoparticles are synthesized by means of atmospheric pressure inert gas electrical discharge evaporating a silver electrode, leading to the formation of particles of a few nanometers in size. The aerosol then flows through the cotton fabric, where silver nanoparticles are partially retained. The size distribution of the primary particles mostly depends upon the type of discharge and nature of the carrier gas. The process is a purely physical one; there are no reactions, and byproducts and wastes are not produced. Stabilizers

and modifiers are also not used. Furthermore, the gas is recirculated in a vacuum tight loop; thus, nanoparticles are not released during normal operation.

### 2. MATERIALS AND METHODS

#### 2.1 Synthesis of Silver Nanoparticles

Silver nanoparticles are synthesized by electrical discharge between two electrodes in inert gas flow at atmospheric pressure. The aerosol generator consists of a cylindrical stainless steel chamber with several ports through which the electrodes are inserted and positioned inside the chamber, the carrier gas enters and the aerosol exits the chamber. All ports are sealed by vacuum flanges and the chamber is evacuated ( $10^{-5}$  mbar) prior to nanoparticle synthesis. The electrodes are aligned facing each other a certain distance apart (gap). The discharge is driven by a capacitor charger formed from a high voltage power supply and a capacitor bank connected parallel each other and to the electrode gap. One electrode is connected to the positive high voltage output of the power supply and the other electrode is grounded. The current delivered by the power supply ( $\sim$  mA), charges the capacitor up to the point that the voltage across the gap exceeds the gas breakdown voltage ( $\sim$  kV) and, then, the capacitor discharges through the gap. This occurs as a pulse of duration of a few microseconds which repeats at a frequency that increases with current (spark discharge). By further increasing the current the voltage drops down to a few hundred of volts, capable to sustain a current of a few hundred of milliamps. Then, a continuous discharge regime is attained (glow discharge). Dur-

\* [esther.hontanon@uni-due.de](mailto:esther.hontanon@uni-due.de)

ing an electrical discharge, highly energetic positive ions are launched from the plasma towards the consumable electrode, where they interact with the surface atoms releasing electrons, heating and melting the electrode surface at the locations where the ions impinge. In glow discharge, Joule effect also contributes to heating the electrodes. As a result, material vaporizes from the electrode surface and enters the gap, where the vapor forms small nanoparticles (primary particles) that grow downwards of the plasma region. In this work, silver nanoparticles are produced in two setups optimized for spark discharge at the Delft University of Technology (Fig. 1a) and for glow discharge at the University of Duisburg-Essen (Fig. 1b) [10, 11].

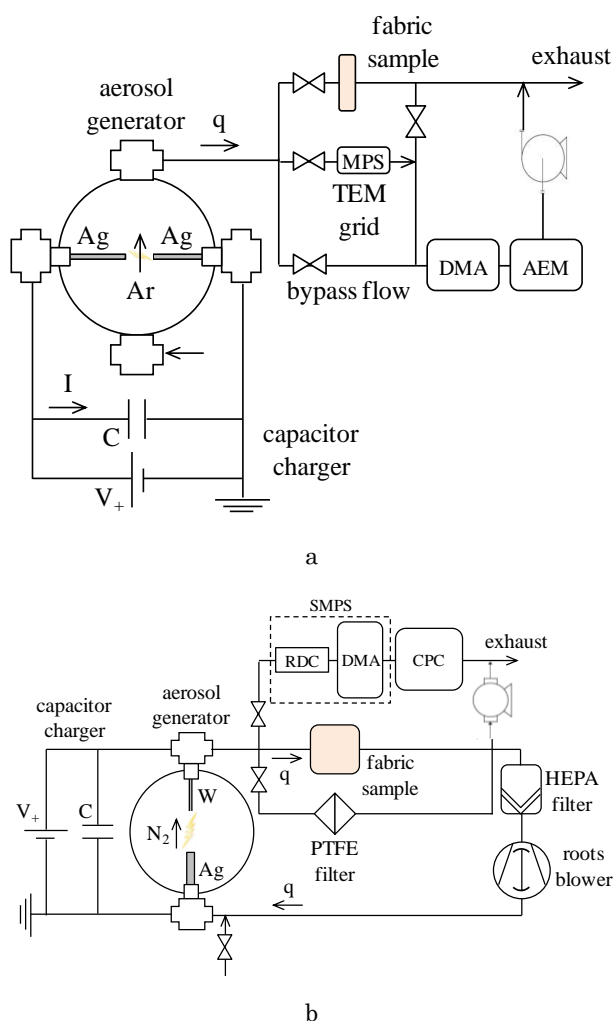

**Fig. 1** – Setup for the synthesis of silver nanoparticles by means of spark discharge (a) and glow discharge (b)

A major difference between the setups in Fig. 1 lies in the electrode and flow arrangement. The spark generator uses two silver rods of the same diameter (7.0 mm) separated by a gap of 1 mm, across which the gas flows normally to the electrode axis (crossflow) in upward direction. During sparking both electrodes are about equally consumed. In the glow generator, the electrodes are a silver rod (10.0 mm) and a tungsten wire (1.6 mm) and the gap length is adjustable (1-15 mm). The gas flows parallel to the electrodes (coflow) in upward direc-

tion. High purity electrodes ( $\geq 99.900\%$ ) and gases (99.999%) are used. The aerosol particle size distribution is monitored by using a differential mobility analyzer (DMA) together with an aerosol electrometer (AEM), and by a scanning mobility particle sizer (SMPS) followed by a condensation particle counter (CPC). Aerosol particles are collected onto TEM grids and PTFE filters. Particle crystallinity is analyzed by wide angle X-ray scattering (WAXS); primary particle size and particle morphology are determined by small angle X-ray scattering (SAXS) and transmission electron microscopy (TEM).

## 2.2 Application to Cotton Fabrics

Fig. 2a shows a SEM image of the woven cotton fabric used in this work (140-150 g/m<sup>2</sup>). Circular (7 and 9 cm) and rectangular (40×20 cm<sup>2</sup>) samples of cotton fabrics are placed in gas tight holders and installed in the process line facing the aerosol flow. Then, the cotton samples are coated with silver nanoparticles by aerosol filtration. As the aerosol approaches a fiber, particles may deposit on the fiber by the simultaneous action of several mechanisms, as depicted in Fig. 2b [12]. Inertial impaction occurs when a particle, by its inertia, departs from the gas stream line and hits the fiber. Interception takes place because a particle has a finite size, which leads to deposition when the particle comes to a position within one particle radius of the fiber surface. For particles smaller than a few tenths of micrometers, the Brownian motion can be sufficiently strong to move the particles from the flow streamline to the fiber. Electrostatic forces arise when particles or fibers carry electrical charges. For nanoparticles, deposition on fibers takes place mainly by convective Brownian diffusion and interception. Impaction and electrostatic forces may also play important roles under certain conditions. The particle collection efficiency and flow pressure drop through the fabric (permeability) are the macroscopic parameters most relevant to aerosol filtration. They depend on the size distribution, morphology and charge state of the particles and on the gas filtration velocity.

## 2.3 Assessment of Bactericidal Property

The bactericidal activity of the cotton fabrics doped with silver nanoparticles is assessed against *Staphylococcus aureus* (SA), a Gram-positive bacterium, and *Klebsiella pneumoniae* (KP), a Gram-negative bacterium, according to the ISO 20743 test method, specific to antibacterial finished textile products. This quantitative method involves several basic steps: 1) sterilize (UV or autoclave) the sample to remove any ambient organisms or contaminants; 2) apply a known number of the target bacteria strain to the sample; 3) maintain the sample at room temperature to allow the bacteria to grow; 4) after a fixed time, extract and count the bacteria remaining on the sample; and 5) compare the remaining bacteria in the treated sample against an untreated sample of the same fabric to assess the antimicrobial performance resulting from the treatment. In ISO 20743, values of the antibacterial activity between 2 and 3 indicate “significant” antibacterial property and values above 3 correspond to “strong” bactericidal property.

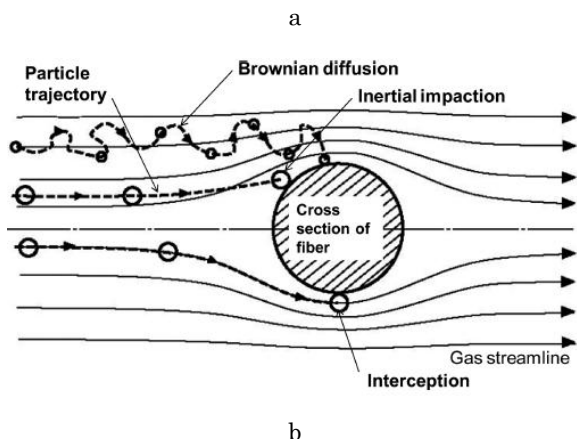
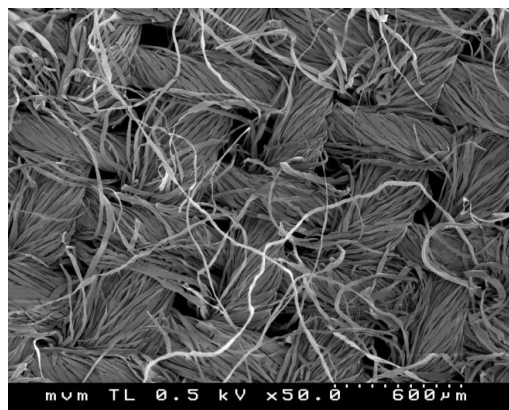

Fig. 2 – Cotton fabric (a) and mechanisms of particle capture on a fiber [12]

3. RESULTS AND DISCUSSION

Table 1 summarizes the main features of seven experiments in which silver nanoparticles were generated and deposited onto cotton fabrics via the aerosol route described in section 2. The size distribution of the primary particles of silver was determined, and the values of the mode (most probable value) are given in Table 1.

Table 1 – Coating of cotton fabrics with silver nanoparticles: Filtration parameters, primary particle size and color of fabric sample after filtration

Sample	Fabric surface area (cm <sup>2</sup> )	Flow surface velocity (cm/s)	Duration (h)	Primary particle size (nm)	Fabric Color
S1	63.6	2.6	7	4 <sup>a</sup>	yellow
S2	800	10.4	1	6 <sup>b</sup>	orange
S3			4		dark orange
S4	38.5	86.6	1.5	15-18 <sup>c</sup>	light gray
S5			10		dark gray
S6			3		dark gray
S7			5		dark gray

<sup>a</sup> Spark: 16 mJ, 60 Hz - Ar, 10 lpm - DMA+AEM, TEM

<sup>b</sup> Glow: 400 mA, 300 V - N<sub>2</sub>, 500 lpm - SMPS

<sup>c</sup> Glow: 600 mA, 300 V - N<sub>2</sub>, 200 lpm - SAXS, TEM

Fig. 3 shows TEM images of silver nanoparticles generated by spark discharge in Ar and deposited on a grid, and generated by glow discharge in N<sub>2</sub> (600 mA, 200 lpm) and collected on a filter. A high population of nanoclusters of a few nanometers in size (<10 nm) are observed in Fig. 3a, whereas larger nanoparticles (10-20 nm) are seen in Fig. 3b. A diffractogram (SWAXS) of silver nanoparticles is depicted in Fig. 4; nanoparticles are polycrystalline and pure silver metal.

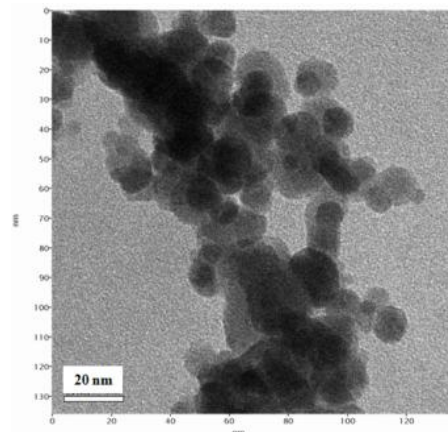
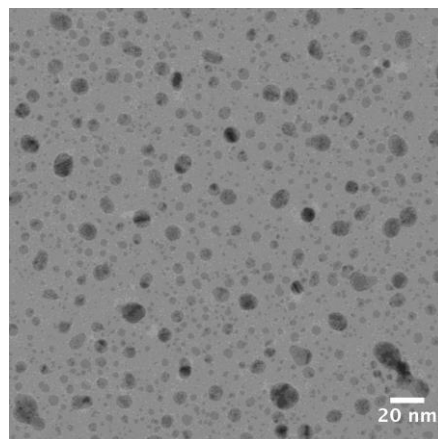

Fig. 3 – Nanoclusters of silver obtained by spark discharge (a) and silver nanoparticles produced by glow discharge (b)

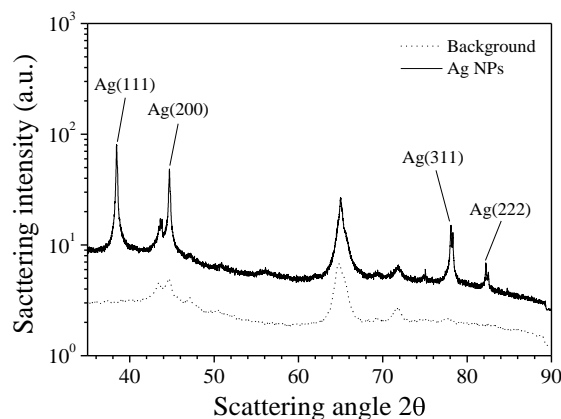

Fig. 4 – Diffraction pattern of silver nanoparticles



All samples changed color in the experiments. The color is determined by the primary particle size and the particle load on the fibers. The samples were analyzed by SEM. No particles were found on the fibers in samples S1 and S2, and only scarcely in sample S3; although the color of the samples evidences they contain nanosilver (e.g. Fig. 5). The reason is that nanoparticles are below the SEM resolution limit (10 nm). The TEM images in Fig. 6a and Fig. 6b correspond to samples S4 and S6. The aerosol source is the same in both cases but the residence time and, hence, particle agglomeration is more significant for S6. Isolated small nanoparticles uniformly cover the cotton fiber in Fig. 6a, while larger agglomerates and much less small nanoparticles are observed in Fig. 6b.



Fig. 5 – Sample S1 with yellow color imparted by nanosilver



a



b

Fig. 6 – Cotton fibers coated with silver nanoparticles: Samples S4 (a) and S6 (b)

The results of the antimicrobial tests conducted with the cotton fabric samples are displayed in Fig. 7. The bactericidal activity of sample S1 for KP was not assessed. The antibacterial activity of all samples exceeds 2 with the exception of sample S4 for SA. Samples S1, S2 and S3 are coated with non-aggregated small nanoparticles (<10 nm), leading to “strong” bactericidal activity, with values between 4 and 5 for both bacteria, almost regardless of the filtration time. Larger nanoparticles of different aggregation levels cover samples S4 to S7, resulting in “significant” bactericidal activity, with values above 2; except for S5, which antibacterial activity for SA reaches 4.82. Samples S6 and S7, containing larger fractions of particle agglomerates, show bactericidal activity for KP only slightly lower than that of samples S4 and S5, where nanoparticles are non-aggregated.

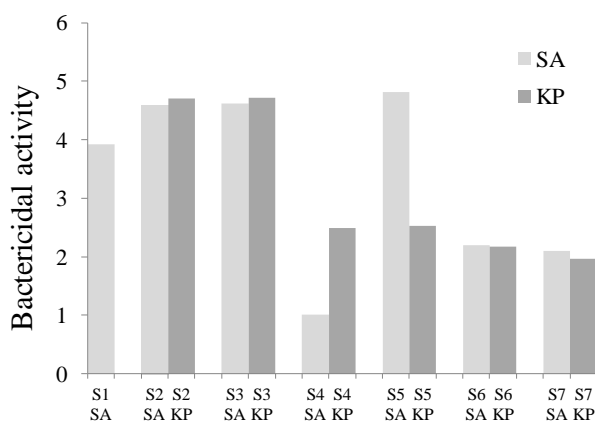

Fig. 7 – Bactericidal activity of cotton fabrics coated with silver nanoparticles

4. CONCLUSIONS

A green aerosol process has been proved for antibacterial nanosilver finishing of cotton fabrics. Fundamental studies will be undertaken to gain insight into nanoparticle filtration behavior of cotton fabrics. Also, further effort will be made to optimize parameters most relevant to bactericidal property such as primary particle size and nanoparticle load on cotton fibers. Finally, the wash durability of silver nanoparticle coatings on cotton fibers will be assessed.

ACKNOWLEDGEMENTS

This research work has been financially supported by the European Union’s Seventh Framework Program (EU FP7) under Grant Agreement No. 280765 (BUONAPART-E). The authors are grateful to Dr. David Ortiz de Zárate (Polytechnic University of Valencia, Spain) for enabling to perform SEM analyses of cotton fabrics samples.

## REFERENCES

1. M. Rai, A. Yadav, A. Gade, *Biotechnol. Adv.* **27**, 76 (2009).
2. R. Dastjerdi, M. Montazer, *Colloid Surface B* **79**, 5 (2010).
3. N. Gokarneshan, P.P. Gopalakrishnan, B. Jeyanthi, *ISRN Nanomat.* 193836 (2012).
4. S. Iravani, H. Korbekandi, S.V. Mirmohammadi, B. Zolfaghari, *Res. Pharm. Sci.* **9**, 385 (2014).
5. H. Korkebandi, S. Iravani, Chapter 1: Silver Nanoparticles, *Progress in Molecular and Environmental Bioengineering – From Analysis and Modeling to Technology Applications* (Ed. A. Carpi) (Intech: 2011).
6. Y. Tang, W. He, S. Wang, Z. Tao, L. Cheng, *Crys-EngComm* **16**, 4431 (2014).
7. P.V. Dong, Ch.H. Ha, L.T. Binh, J. Kasbohm, *Int. Nano Lett.*, **2**, 9 (2012).
8. J.M. Rad, T.D. Isfahani, I. Hadi, S. Ghalamdaran, J. Sabbagzadeh, M. Sharif, *Appl. Nanosci.* **1**, 27 (2011).
9. V.K. Sharma, R.A. Yngard, Y. Lin, *Adv. Colloid Interface Sci.* **145**, 83 (2009).
10. T.V. Pfeiffer, J. Feng, A. Schmidt-Ott, *Adv. Powder Res.* **21**, 56 (2014).
11. E. Hontañón, J.M. Palomares, M. Stein, X. Guo, R. Engeln, H. Nirschl, F.E. Kruis, *J. Nanopart. Res.* **15**, 1957 (2013).
12. Ch. Wang, Y. Otani, *Ind. Eng. Chem. Res.* **52**, 5 (2013).