



Vaneev S. M., Martsinkovskiy V. S., Kulikov A., Miroshnichenko D. V., Bilyk Ya. I., Smolenko D. V., Lazarenko A. D. (2021). Investigation of a turbogenerator based on the vortex expansion machine with a peripheral side channel. *Journal of Engineering Sciences*, Vol. 8(1), pp. F11–F18, doi: 10.21272/jes.2021.8(1).f2

Investigation of a Turbogenerator Based on the Vortex Expansion Machine with a Peripheral Side Channel

Vaneev S. M.^{1*}, Martsynkovskyy V. S.², Kulikov A.³, Miroshnichenko D. V.⁴, Bilyk Ya. I.², Smolenko D. V.¹, Lazarenko A. D.¹

¹ Sumy State University, 2 Rymskogo-Korsakova St., 40007 Sumy, Ukraine;

² TRIZ Ltd., 1, Mashynobudivnykiv St., 40020 Sumy, Ukraine;

³ Technical University of Košice, 31, Šturova St., 080 01 Prešov, Slovakia;

⁴ TOV “NVP “ARMA-T” Ltd., 1, Rymskogo-Korsakova St., 40007 Sumy, Ukraine

Article info:

Received:

February 17, 2021

The final version received:

May 16, 2021

Accepted for publication:

May 21, 2021

*Corresponding email:

s.vaneev@kttf.sumdu.edu.ua

Abstract. The creation of energy-saving turbogenerators is an essential component of the development of small energy systems. The gradual growth of interest in distributed electricity generation necessitates the constant improvement of these units. Moreover, they implement a more environmentally friendly generation method than when using microturbine units that use fuel to carry out the work process. Nowadays, turbogenerators are created based on different types of expansion machines, which have their advantages and disadvantages, given in this article. Compared to competitors, vortex expansion machines have good prospects and the necessary potential to expand their research and produce turbogenerators. An experimental vortex expansion machine with a peripheral-lateral channel and ability to change the geometric parameters of its flowing part was created to meet these needs. Experimental studies of the machine were performed on a special stand with air as a working fluid. As a result of the tests, the data were successfully obtained and processed. They are presented in the form of tables and graphical dependencies. The nature of the influence of thermodynamic parameters and geometric parameters of the flow part on the efficiency of the vortex expansion machine and turbogenerator based on it to further improve and create new turbogenerators is clarified.

Keywords: energy saving turbogenerator, vortex turbine, change of geometrical parameters, utilization, the energy of excess gas pressure.

1 Introduction

The load on energy systems in the modern world only increases with the increasing capacity and number of consumers. It is necessary to generate more and more electricity, which increasingly busy networks must endure. The development of small energy systems can reduce the load on them or even solve this problem.

The efficiency of mini-power plants is relatively high, and there are many types of installations, e.g., mini-CHPs, mini-hydropower plants, geothermal, wind and solar, and heat pump installations.

Such stations are closest to consumers, which minimizes losses on energy transportation, which is why they are considered the future of energy.

2 Literature Review

The electricity needs of large consumers can be met by conventional gas turbines, while micro-turbine plants are increasingly meeting the needs of small and medium-sized consumers. These machines have their power up to 500 kW but can provide power up to 2–3 MW when combined. Microturbine units usually include a compressor, radial turbine, inverter, and recuperator. The efficiency of such plants in the production of electricity is low, but the efficiency is increased significantly in the case of using the cogeneration process and other related systems. The main disadvantage of these plants is the need for fuels such as natural gas, associated petroleum gas, biogas, and alike. There are many schemes for their improvement, but the use of additional resources is costly and not always possible, and in the process of work, in any

case, combustion products are formed, harmful to the environment [1].

A more environmentally friendly way is using turboexpander units in places of gas throttling at gas distribution stations and points in various industrial processes [2–4]. The generation is economically profitable for the development of enterprises and the energy system as a whole, so the topic is essential and relevant [5–7].

There are known examples of the construction of such plants using different types of turbines and related systems. Reciprocating machines are relatively inexpensive but rather bulky, have many moving parts, create significant vibrations, the oil in them comes into contact with the working fluid and needs regular replacement, frequent stops are needed for repairs. Expanders with a rolling piston due to the specific design and internal friction require frequent replacement of parts [8]. At power up to 500 kW, application of vortex expanding machines is possible. As centripetal, axial, and jet-reactive [9], they have a single moving part – the rotor, but lower speeds, which allows gearless execution (for example, with the location of the impeller directly on the generator shaft), providing greater compactness and reliability at lower levels noise. The work [10] is devoted to a turbogenerator based on a screw installation. Compared to it, vortex machines are easier to manufacture and maintain because they use an oil-free working cavity, which significantly simplifies the design, and there are no technologically complex parts such as screws. Prospects for using these energy-saving installations are gradually expanding with the improvement of electronics – increasing the operating time of equipment without human intervention.

Vortex machines have a large variety of flowing parts due to the complex spiral motion of the gas along the length of the flowing part, so they are studied to varying degrees by scientists. For example, turbines with an external peripheral channel are the most studied, and those with a side and peripheral side channel are less studied,

which provides a wide field for further study and improvement.

3 Research Methodology

Employees of TRIZ Ltd. and Sumy State University calculated according to the existing method of calculating vortex expansion machines and then designed and manufactured a turbine with a peripheral side channel (Figure 1). Its design is made two-channel four-stream and involves changing the geometric parameters of the machine. In addition, experimental tests were performed on an air stand (Figure 2) and involved changing the geometric parameters of the flow part of the turbine (Figure 3).

The schematic diagram of the stand is shown in Figure 4.

The studied turbogenerator consists of a vortex expansion machine and an electric generator connected to each other fearlessly through a coupling. An electric motor with a capacity of 10 kW is used as an electric generator. The purpose of the vortex expansion machine is to convert the energy of excess gas pressure by expanding it in the flowing part of the turbine to obtain mechanical work on the machine's shaft.

The working fluid is fed to the vortex turbine via a pipeline from the compressor. Once in the turbine, the flow of gas through the nozzle moves to the flow part, which is formed by the channel of the housing and the interscapular channels of the impeller. The movement of gas particles in these channels is accompanied by a change in the direction and magnitude of the speed, the moment of movement, as a result of which forces appear on the blades, which ensure the rotation of the impeller. Finally, the gas is discharged from the flowing part through the housing and the pipe into the atmosphere. Between the nozzle and the outlet, a cutter is used.

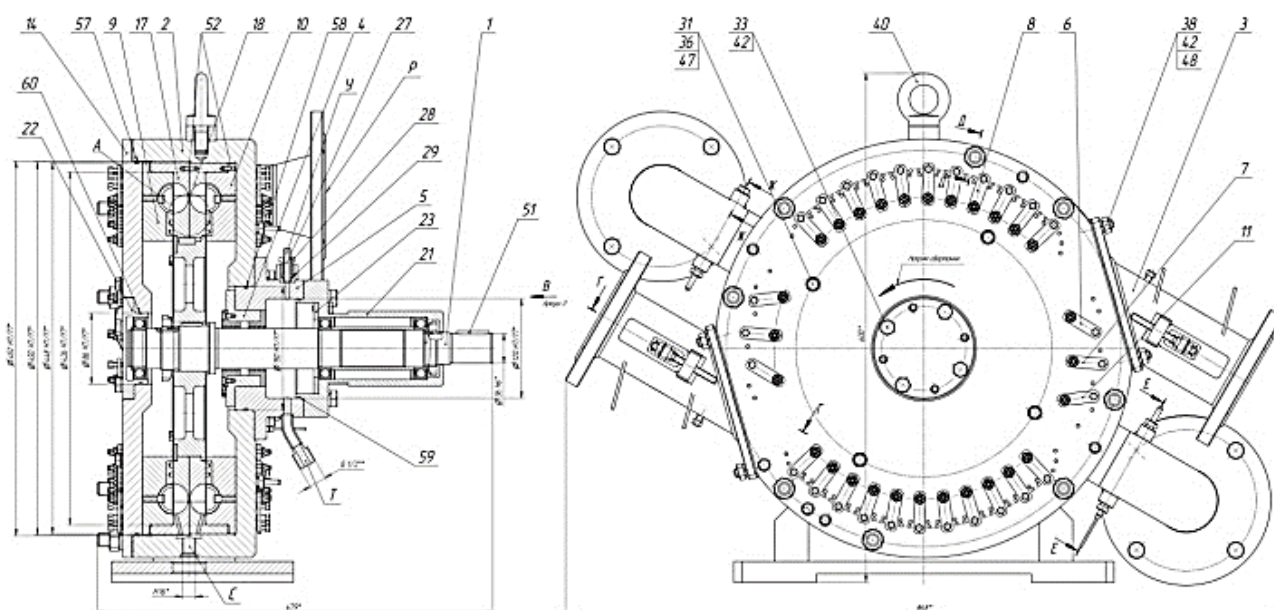

Figure 1 – Turbine drawing

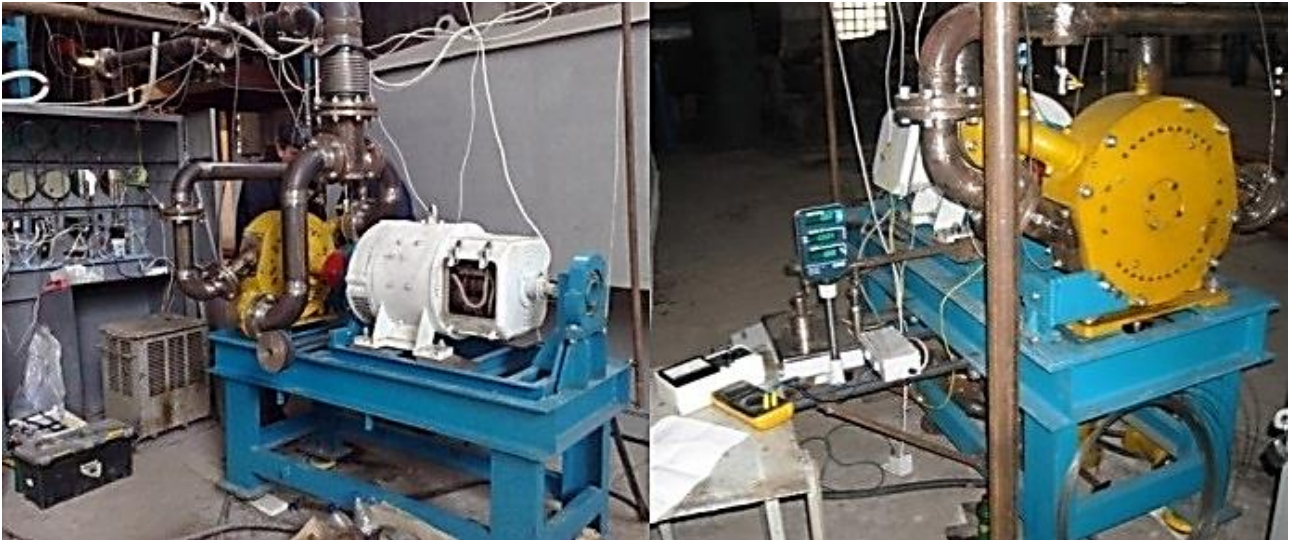

Figure 2 – General view of the turbogenerator on the experimental stand

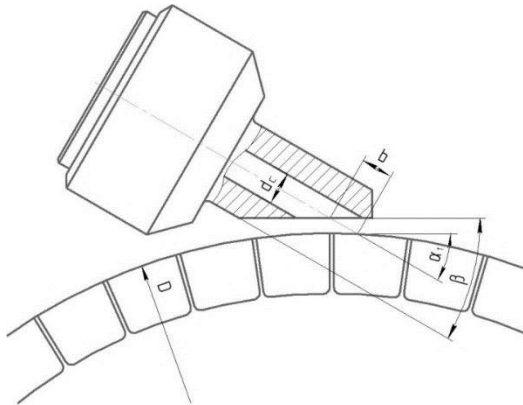

Figure 3 – Main geometric parameters of the flowing part of the machine

During the tests, the pressure at the inlet and outlet of the turbine and the rotor speed changed. Excess pressure at the inlet to the turbine varied from 1 to 5 kg/cm², the pressure at the outlet of the turbine was equal to atmospheric pressure, and, for some modes, was set equal to 1.85 kg/cm², the turbine rotor speed was up to 3000 rpm.

Different geometrical parameters significantly impact the efficiency of energy transfer from the gas flow to the impeller blades. During the research of this turbine, the angle of inclination of the nozzles α_1 , the angle of cut of the nozzles β , and the distance from the nozzles to the blades of the impeller b changed (Figure 3). The primary geometric parameters of the turbine flow are shown in Figure 3, and the change of parameters during testing of the machine is shown in Table 1. Radial gas supply to the impeller is used with an outer diameter $D = 370$ mm with a solid separator and flowing part without guide vanes.

A total of 147 tests were performed: with excess pressure at the inlet $p_{in} = 1; 2; 3; 4; 5$ kg/cm² and at the outlet $- p_{out} = 0; 1.85$ kg/cm² at rotor speeds n from 0 to 3000 rpm in increments of 500 rpm.

Table 1 – Change of the geometric parameters of the flow part of the vortex turbine

Nozzle angle $\alpha_1, ^\circ$	Nozzle cut angle $\beta, ^\circ$	Distance from nozzles to impeller b, mm
30	30	1
30	30	5
30	30	10
30	30	15
45	45	1
45	45	5
45	45	10
45	45	15
60	60	1

During the tests on the stand, the control of necessary parameters is provided: gas pressure before the diaphragm, pressure at the inlet to the turbine and in its case, pressure at the turbine outlet, gas temperatures behind the diaphragm and at the turbine inlet, diaphragm pressure drop, rotor speed and torque on the dynamometer shaft. An electric generator is used as a dynamometer. The stator is embedded in the bearing racks, considering the possibility of rocking. Its movement is transmitted to the dial of the scales through a lever balanced by a counterweight. A complete list of measured parameters and devices is given in Table 2.

4 Results and Discussion

The test results are shown graphically in Figures 5-12. The efficiency of the vortex machine is determined by considering the mechanical losses in the generator, including losses on the fan, i.e., in practice - this is the efficiency of the turbogenerator. When estimating the efficiency of the vortex turbine, these losses are not considered, so the resulting efficiency of the turbine will be higher.

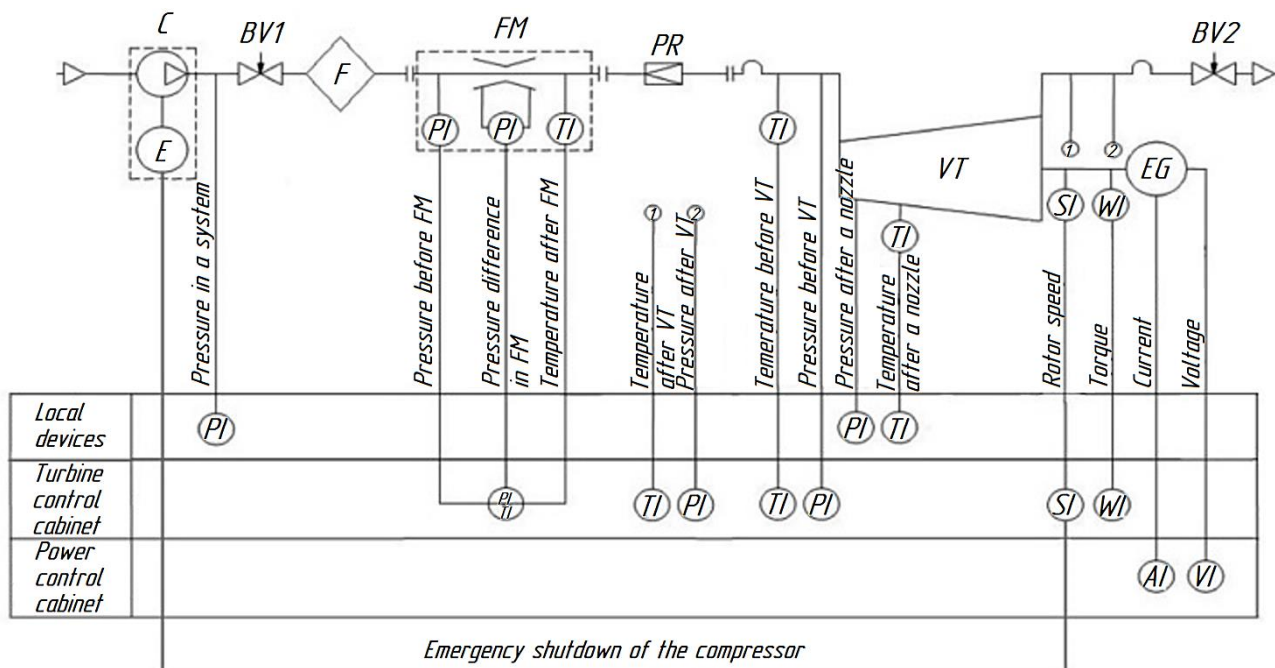

Figure 4 – Schematic diagram of the stand: E – engine; C – compressor; VT – vortex turbine; EG – electric generator; PR – pressure regulator; BV1, BV2 – ball valves; FM – flow meter; F – filter; FI – flow meter display unit; PI – manometer unit; TI – thermometer; SI – tachometer unit; WI – torque display unit; AI – amperemeter; VI – voltmeter

Table 2 – The list of measured parameters and control-measuring devices used for their measurement

Marking on the diagram	Functional purpose	Device name	Device type(s)	Measure range	Accuracy class	Quality class
PI-01	Network pressure	Manometer	MTI	0 – 10 kgf/cm ²	0.6	10
PI-03	Outlet pressure					
PI-10	Inlet pressure					
PI-11	After-nozzle pressure					
PI-14–PI-19	Pressure distribution on the flow part					
FI-06	Air consumption	Flow-meter	PM1	0 – 30 nm ³ /min	4.0	1
TE-08, TI-02	Inlet temperature	Electronic thermometer (temperature sensor and display unit)	TCM-101; II-TC	–40 – +180 °C	0.5	3
TE-12, TI-09	After-nozzle temperature					
TE-22, TI-13	Outlet temperature					
WE-23, WI-24	Torque	Scales	CAS AP-15M	0–15 kgf	0.1	1

Figure 5 shows the dependence of power on the turbogenerator shaft from the shaft speed and the pressure at the inlet to the turbine (nozzle angle $\alpha_1 = 30^\circ$, nozzle cut angle $\beta = 30^\circ$, distance from nozzles to the impeller $b = 1$ mm).

For the pressure at the inlet to the turbine of 6 kg/cm², (absolute) graphical dependencies are given at the degrees of pressure reduction in the turbine $\Pi = 2$, and $\Pi = 6$. It is seen that up to 2000 rpm power increases almost directly in proportion to the shaft speed.

Figure 6 shows the dependences of the turbogenerator efficiency on the shaft speed and angle α_1 (Figure 3) at different values of the degree of pressure drop in the turbine. It is seen that when the speed of the turbogenerator shaft is more than 2000 rpm in all cases, the efficiency at $\beta = 30^\circ$ is greater than in variants with other angles. As the shaft speed increases, the efficiency increases.

Figure 7 presents the dependences of the efficiency of the turbogenerator on the angle α_1 at different values of the shaft speed and the degree of pressure drop in the turbine. Increasing the angle α_1 in the study range and decreasing the shaft speed causes a decrease in efficiency.

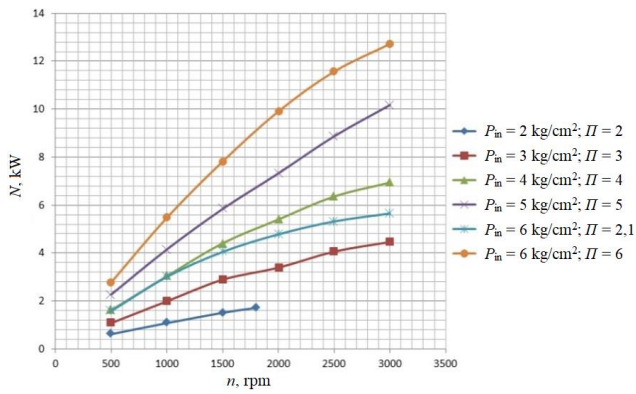

Figure 5 – Dependence of turbogenerator power on rotor speed

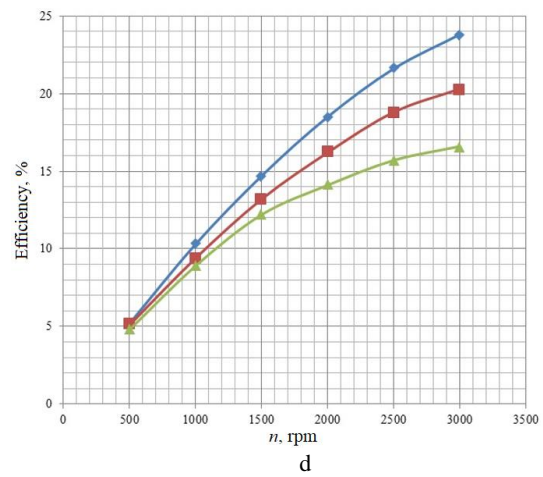

Figure 6 – Dependence of turbogenerator efficiency on rotor speed at different values of the degree of pressure drop in the turbine: a) $\Pi = 3$; b) $\Pi = 4$; c) $\Pi = 5$; d) $\Pi = 6$

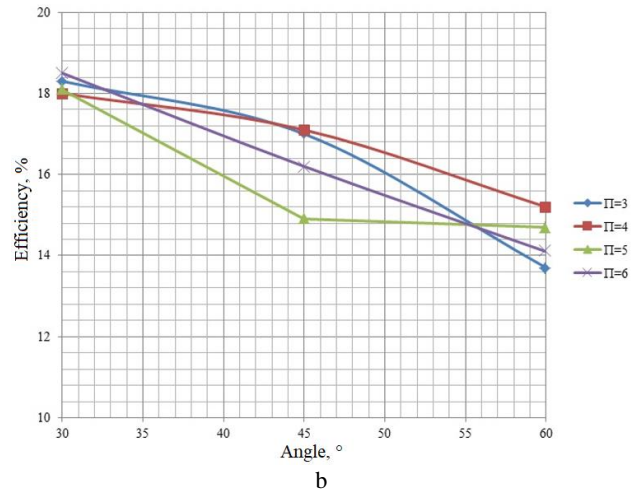
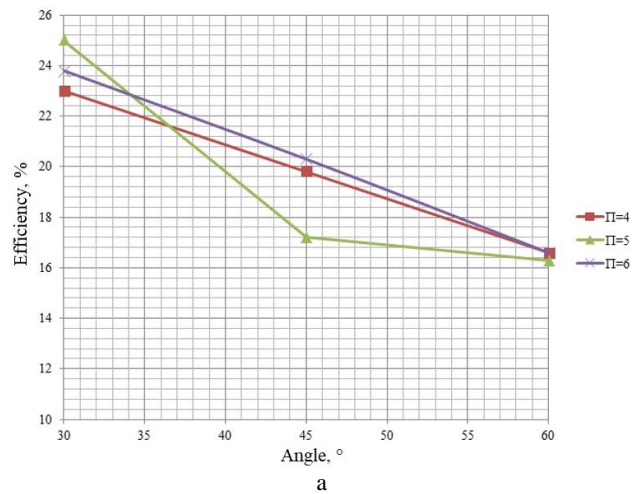
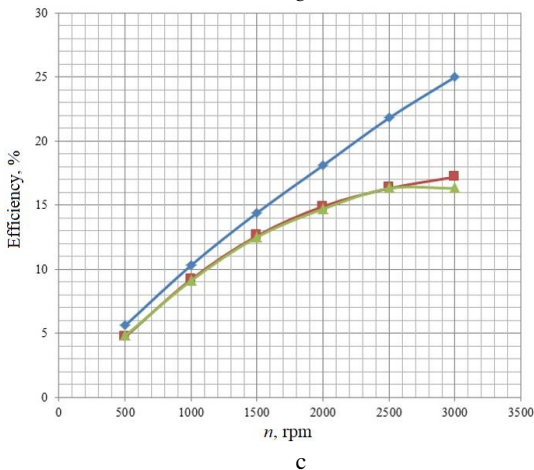
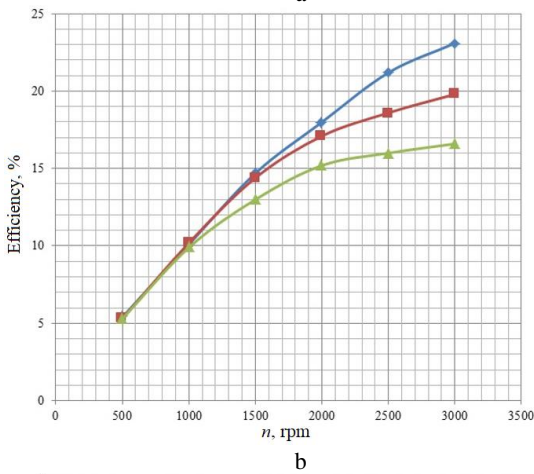
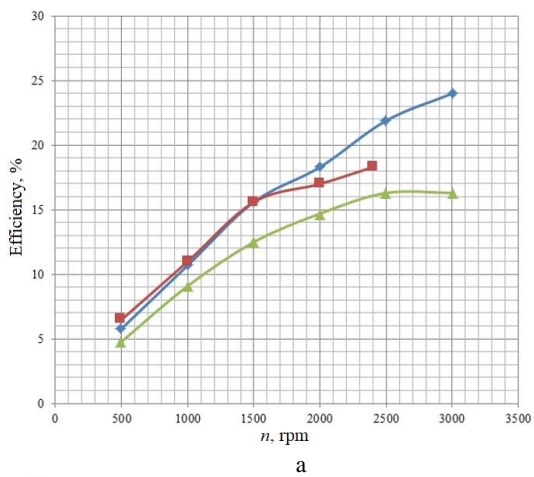

Figure 7 – Dependence of efficiency on the angle of the nozzles α_1 at different values of the speed of the turbogenerator shaft: a) 3000 rpm; b) 2000 rpm

Figure 8 shows the dependences of the efficiency of the turbogenerator on the shaft speed, the gas pressure at the inlet to the turbine, and the degree of pressure drop in it at different values of the angle α_1 . It is seen that at the gas pressure at the inlet to the turbine in the range of

3–6 kg / cm² (2–5 kg/cm² excess pressure) for specific values of the speed of the turbogenerator shaft efficiency differs by no more than 3 % and increases with increasing shaft speed.

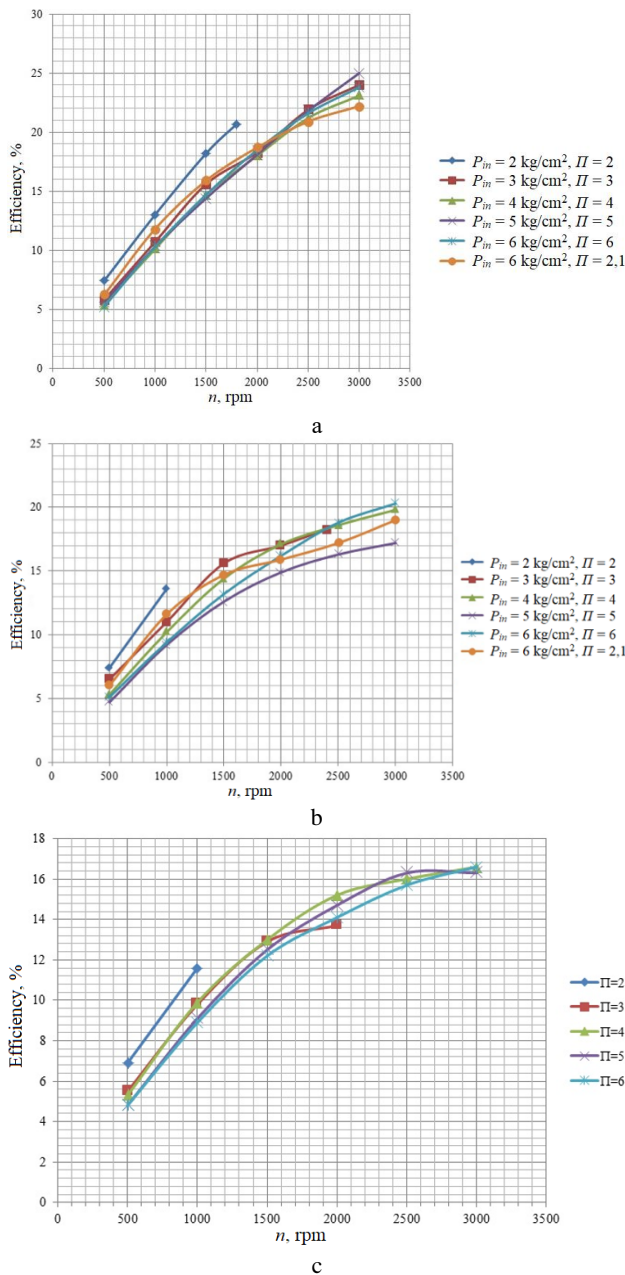

Figure 8 – Dependence of efficiency on rotor speed at different values of angle α_1 : a) $\alpha_1 = 30^\circ$; b) $\alpha_1 = 45^\circ$; c) $\alpha_1 = 60^\circ$

In the theory and practice of turbomachines, the dimensionless complex of the specific circumferential speed of the impeller is essential and widely used, as well as the dependence of the efficiency of the turbomachine on this complex. Moreover, it characterizes the load of the turbine, linking together the parameters that reflect the physical properties of the working fluid and the state of gas flow at the inlet and outlet of the turbine, with the design values and speed of the turbine shaft:

$$\bar{U} = \frac{U}{C_s} = \frac{\pi \cdot D \cdot n}{60 \cdot C_s'} \quad (1)$$

where D – outer diameter of the impeller, m; n – impeller speed, rpm; C_s – isentropic gas velocity, that characterizes the available specific work of the expansion machine, m/s:

$$C_s = \sqrt{2h_s} = \sqrt{\frac{2k}{k-1} T_{in}^* R \left(1 - \Pi^{\frac{1-k}{k}}\right)}, \quad (2)$$

where h_s – specific isentropic difference of enthalpies (available specific work of the expansion machine), J/kg; k – an indicator of the isentropy of the working fluid; R – specific gas constant, J/(kg·K); T_{in}^* – gas flow total temperature at the inlet of the machine, K; Π – degree of pressure drop in the expansion machine.

Figure 9 shows the dependences of the efficiency of the turbogenerator on the specific circumferential speed of the impeller and the degree of pressure drop in the turbine (angle of the nozzles $\alpha_1 = 30^\circ$; the angle of the nozzles $\beta = 30^\circ$; the distance from the nozzles to the impeller $b = 1 \text{ mm}$).

The most significant values of the efficiency of the vortex turbine with a peripheral side channel during the tests correspond to the values of the specific circumferential speed from 0.080 to 0.142. The maximum value of efficiency = 0,25 is received at the specific circumferential speed of 0.12. It is seen that in the whole studied range of the degree of pressure reduction in the turbine for specific values of the specific circumferential speed of the impeller, the efficiency differs by no more than 3 %. Given the upward nature of the graphical dependence of efficiency, it is expected to obtain higher values in the area not included in this study.

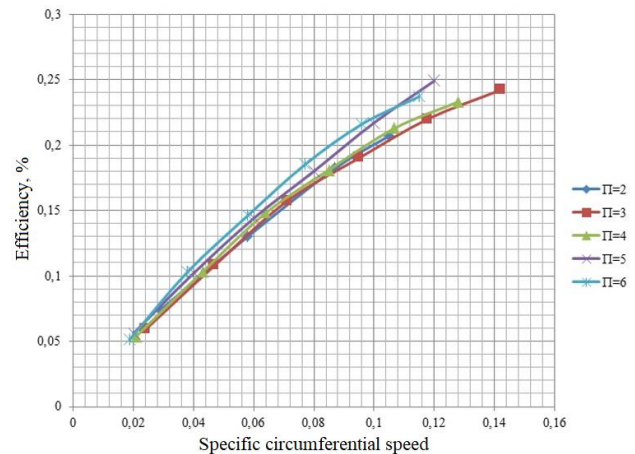

Figure 9 – Dependence of turbogenerator efficiency on the specific circumferential speed of the impeller

The influence of the distance from the nozzles to the impeller b on the power on the turbogenerator shaft for excess pressure at the turbine inlet 5.0 kg/cm² and 1.85 kg/cm² at the outlet (for a pressure ratio of 2.1) is shown in Figures 10–11 (nozzle angle $\alpha_1 = 30^\circ$; nozzle cut angle $\beta = 30^\circ$). Analysis of graphical dependences shows that the distance from the nozzle cut to the impeller blades has little effect on the power of the turbogenerator, especially in the range $b = 1\text{--}5 \text{ mm}$.

Since the gas flow rate does not depend on the distance of the nozzle cut to the impeller blades, the dependences of the efficiency on the shaft speed and the distance b are identical to the dependences for power (Figure 12).

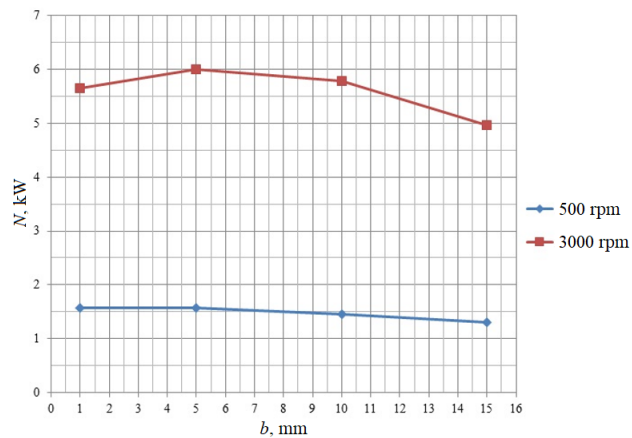

Figure 10 – Dependence of turbogenerator power on the distance from the nozzles to the impeller

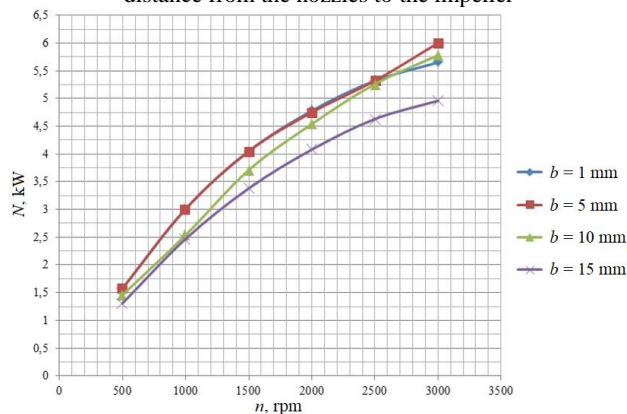

Figure 11 – Dependence of turbogenerator power on the speed at a variable distance from nozzles to the impeller

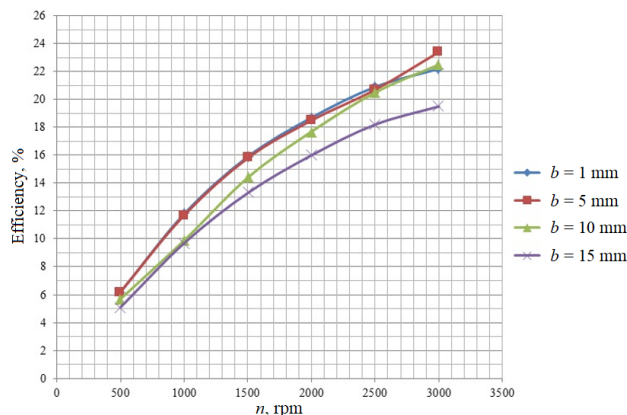

Figure 12 – Dependence of efficiency of the turbogenerator on the frequency of rotation at a variable distance from nozzles to an impeller

5 Conclusions

Experimental tests of a vortex expansion machine with a peripheral side channel and a turbogenerator based on it were carried out on a research stand. The information-measuring system allowed to record of the parameters during the tests with sufficient accuracy. The obtained experimental data are processed and presented in the form of tables and figures.

The experiment showed that the power of the turbine increases almost in direct proportion to the speed of its rotor. Consequently, the efficiency of the turbine also increases with increasing rotor speed.

The highest values of the efficiency of the turbogenerator based on a vortex turbine with a peripheral side channel during the tests correspond to the values of the specific circular speed from 0.080 to 0.142 and increase throughout the interval. Thus, the maximum value of efficiency (25 %) is obtained at the value of the specific circumferential speed of 0.12. Given the ascending nature of this dependence, it is expected to obtain its higher values in the area not covered by this experiment.

It has been found that the angle of the nozzles significantly affects the efficiency of the vortex machine. At the angle $\alpha_1 = 30^\circ$ and speeds greater than 2000 rpm in all cases, the highest efficiency is obtained. An increase in the angle α_1 in the studied range causes a decrease in efficiency.

The nature of the influence of the distance from the nozzle cut to the turbine impeller has been studied. Experimental studies have shown that this distance has little effect on the power and efficiency of the turbogenerator, especially in the range $b = 1-5$ mm.

The obtained research results can be used to design vortex expansion machines with a peripheral side channel and turbogenerators based on them, to continue their improvement and comparison with machines of other types.

References

1. James, J. A., Thomas, V. M., Pandit, A., Li D., Crittenden, J. C. (2016). Water, Air Emissions, and Cost Impacts of Air-Cooled Microturbines for Combined Cooling, Heating, and Power Systems: A Case Study in the Atlanta Region. *Engineering*, Vol. 2(4), pp. 470–480, doi: 10.1016/J.ENG.2016.04.008.
2. Kim, H., You, H., Choi, K-S. Han S (2020). A Study on Interconnecting to the Power Grid of New Energy Using the Natural Gas Pressure. *Journal of Electrical Engineering and Technology*, Vol. 15, pp. 307–314, doi: 10.1007/s42835-019-00324-5.
3. Arabkoohsar, A., Farzaneh-Gord, M., Deymi-Dashtebayaz, M., Machado, L., Koury, R. N. N. (2015). A new design for natural gas pressure reduction points by employing a turbo expander and a solar heating set. *Renewable Energy*, Vol. 81, pp. 239–250, doi: 10.1016/j.renene.2015.03.043.
4. Pajączek, K., Kostowski, W., Stanek, W., (2020). Natural gas liquefaction using the high-pressure potential in the gas transmission system. *Energy*, Vol. 202, 117726, doi: 10.1016/j.energy.2020.117726.
5. Kuczyński, S., Łaciak, M., Olijnyk, A., Szurlej, A., Wlodek, T. (2019). Techno-Economic Assessment of Turboexpander Application at Natural Gas Regulation Stations. *Energies*, Vol. 12(4), 755, doi: 10.3390/en12040755.
6. Seresht, R. T., Ja, H. K. (2010). Retrofit of Tehran City Gate Station (C.G.S. No. 2) by Using Turboexpander. *ASME 2010 Power Conference*. Chicago, Illinois, USA. pp. 207–212, doi: 10.1115/POWER2010-27087.
7. Ardali, E. K., Heybatian, E. (2009). Energy regeneration in natural gas pressure reduction stations by use of gas turbo expander; Evaluation of available potential in Iran. *Proceedings 24th World Gas Conference*, pp. 5–9.
8. Kolasiński, P., Pomorski, M., Błasiak, P., Rak, J. (2017). Use of Rolling Piston Expanders for Energy Regeneration in Natural Gas Pressure Reduction Stations – Selected Thermodynamic Issues. *Applied Sciences*, Vol 7(6), pp. 1–17, doi: 10.3390/app70605354.
9. Vaneev, S., Rodymchenko, T., Melechuk, S., Baga, V., Bolotnikova, O. (2021). Influence of the degree of off-design of the traction nozzle of a jet reaction turbine on its efficiency. *Journal of Physics: Conference Series*, Vol. 1741, 012004, doi: 10.1088/1742-6596/1741/1/012004.
10. Li, G., Wu, Y., Zhang, Y., Zhi, R., Wang, J., Ma, C. (2016). Performance Study on a Single-Screw Expander for a Small-Scale Pressure Recovery System. *Energies*, Vol 10(1), 6, doi: 10.3390/en10010006.