

PAPER • OPEN ACCESS

Granulation machines with highly turbulized flows: creation of software complex for technological design

To cite this article: A Artyukhov *et al* 2020 *IOP Conf. Ser.: Mater. Sci. Eng.* **776** 012018

View the [article online](#) for updates and enhancements.

You may also like

- [STELLAR SURFACE MAGNETO-CONVECTION AS A SOURCE OF ASTROPHYSICAL NOISE. I. MULTI-COMPONENT PARAMETERIZATION OF ABSORPTION LINE PROFILES](#)

H. M. Cegla, S. Shelyag, C. A. Watson et al.

- [Numerical analysis of temperature field in the high speed rotary dry-milling process](#)

N X Wu, L J Deng and D H Liao

- [GRANULATION IN RED GIANTS: OBSERVATIONS BY THE KEPLER MISSION AND THREE-DIMENSIONAL CONVECTION SIMULATIONS](#)

S. Mathur, S. Hekker, R. Trampedach et al.



The Electrochemical Society
Advancing solid state & electrochemical science & technology

242nd ECS Meeting

Oct 9 – 13, 2022 • Atlanta, GA, US

Abstract submission deadline: **April 8, 2022**

Connect. Engage. Champion. Empower. Accelerate.

MOVE SCIENCE FORWARD



Submit your abstract



Granulation machines with highly turbulized flows: creation of software complex for technological design

A Artyukhov¹, N Artyukhova¹, J Krmela² and V Krmelová³

¹ Processes and Equipment of Chemical and Petroleum-Refineries Department, Sumy State University, 2 Rymyskogo-Korsakova st., 40007 Sumy, Ukraine

² Department of Numerical Methods and Computational Modeling, Faculty of Industrial Technologies in Púchov, Alexander Dubček University of Trenčín, I. Krasku 491/30, 020 01 Púchov, Slovak Republic

³ Department of Materials Technologies and Environment, Faculty of Industrial Technologies in Púchov, Alexander Dubček University of Trenčín, I. Krasku 491/30, 020 01 Púchov, Slovak Republic

E-mail: a.artyukhov@pohnp.sumdu.edu.ua

Abstract. The article deals with author's software products review to calculate devices with highly turbulized flows as a part of granulation units. Principal scheme and model of the granulation unit, algorithm of the granulation technical calculation are represented in the work. The complex automated calculation technique of the granulation units is proposed. The proprietary software for calculation of main stages in the granulation process is observed in the research. Short description and functions of main software products to implement basic algorithm are given: Vortex Flow[©], Conical Channel[©], Conical Granulator[©], Multistage Heat Treatment[©], Vortex Tray[©]. As a result of the optimization calculation, the user of programs will get the following information: optimal construction of the vortex granulator's workspace, necessary number of stages in the multistage shelf drier for granules' final drying, number and construction of the vortex tray with heat and mass transfer-separation elements for exhaust gases cleaning. All software products enable to export the received data and to exchange these data between each other. The complex algorithm and software products, proposed in the article, let to carry out optimization calculation of the main technological equipment in the granulation unit at its designing stage without expensive multifactorial experiment. The presented granulation units' calculation algorithm and software products for its realization enable to carry out equipment changeover if raw material characteristics and the productivity of the unit are changed. The automated calculations results give a base to design industrial granulation unit for porous ammonium nitrate production.

1. Introduction

Nowadays automatization of main processes calculations, carried out in the chemical production, is an essential part of the enterprise's successful operation. Implementation of the informational systems to calculate and to design main equipment of products production units lets to:

- minimize cost for experiments on natural samples of the main equipment in the unit;
- carry out the optimization calculation of device by the optimization criterion, fixed by user;
- provide "flexibility" of calculation if basic data for technological calculation or optimization criterion are changed.



In this research the object is a granulation unit to obtain granulated porous ammonium nitrate (PAN) through humidification and heat treatment of the ammonium nitrate granules. In order to carry out the target and secondary processes, one proposes to use devices with highly turbulized flows as the main equipment, working in the hydrodynamic regime. They are vortex granulator, multistage shelf drier, absorber with vortex mass transfer separation contact elements.

Formation of the complex automated calculation technique of the granulation units will enable simultaneously to carry out constructive and technological calculations of the main equipment.

Aim of the research is to create technique of the granulation units' complex automated calculation using author's applied programs pack.

The author's applied programs pack to calculate some stages of PAN obtaining process is proposed in the article. Their work is based on the author's mathematic models of the hydrodynamics and heat and mass transfer in the vortex highly turbulized flows.

Main programs, included to the optimization calculation complex pack of the granulation unit main equipment to obtain PAN, are described.

The software realization of the author's mathematic models to calculate hydrodynamic and thermodynamic models for hydromechanical, heat and mass transfer processes in the devices with vortex highly turbulized flows, is first proposed.

The presented results of the research enable to carry out optimization calculation of the granulation unit's main technological equipment at its designing stage without expensive multifactorial experiment. Besides, granulation units' calculation algorithm and software products to implement the algorithm, observed in the article, let to fulfill changeover if raw material characteristics and unit's productivity are changed.

2. Literature review

Review of the software products modern base (simulation modeling systems) to calculate units of the chemical industries (Aspen HYSYS®, PRO/II, GasCondOil, ChemCAD, DESIGN II, SIGMAFINE, gPROMS ModelBuilder, GIBBS etc) [1–8] shows that such software products can be mainly used for technological calculation of the equipment with set construction and with concrete technological parameters of the chemical units operation. In order to perform technological calculation, it is necessary to use multiple input of the basic data; there is a large number of such inputs in the optimization calculation. The software products to calculate hydrodynamic and heat and mass transfer processes in the equipment of chemical industry (ANSYS Fluent, COSMOS FlowWorks, FlowVision, Flow-3D CFD, Ansys CFX, COMSOL Multiphysics etc) [9–14] enable to find only one constructive variant of the device on the set solid model that reduces optimization calculation velocity. It should be mentioned that simulation modeling systems and software products for calculation of hydrodynamic and heat and mass transfer processes in the equipment of chemical industry are effective to estimate units with fixed technological parameters and equipment of the set construction. An additional difficulty in implementation of the above products for granulation unit, which is observed in this article, consists in the fact that there are no models to calculate the equipment, suggested by authors as a result of novelty in organization of flows motion, confirmed by a number of protection documents [15–19]. Authors have achieved success in the software realization of the author's mathematic models for calculation of the hydrodynamic and thermodynamic conditions of the vortex granulators' work [20–22], though, the created software products do not fully comprise the whole operation cycle of the main equipment in the granulation unit.

3. Description of the unit and basic algorithm of its calculation

Principal scheme of the PAN obtaining unit with the use of equipment with highly turbulized flows is demonstrated in the figure 1. The target technological processes in PAN production are heat treatment of the ordinary ammonium nitrate after humidification and the PAN final drying, significant secondary process – cleaning of the waste drying agent before its release into the atmosphere or utilization. Given this, basic algorithm of the granulation unit's calculation (technological scheme of the unit is

demonstrated in the figure 2) will be based on the defining of technological operation conditions and constructive characteristics of the vortex granulator (VG), gravitational shelf dryer (GSD) and absorber (A) with vortex mass transfer-separation contact elements.

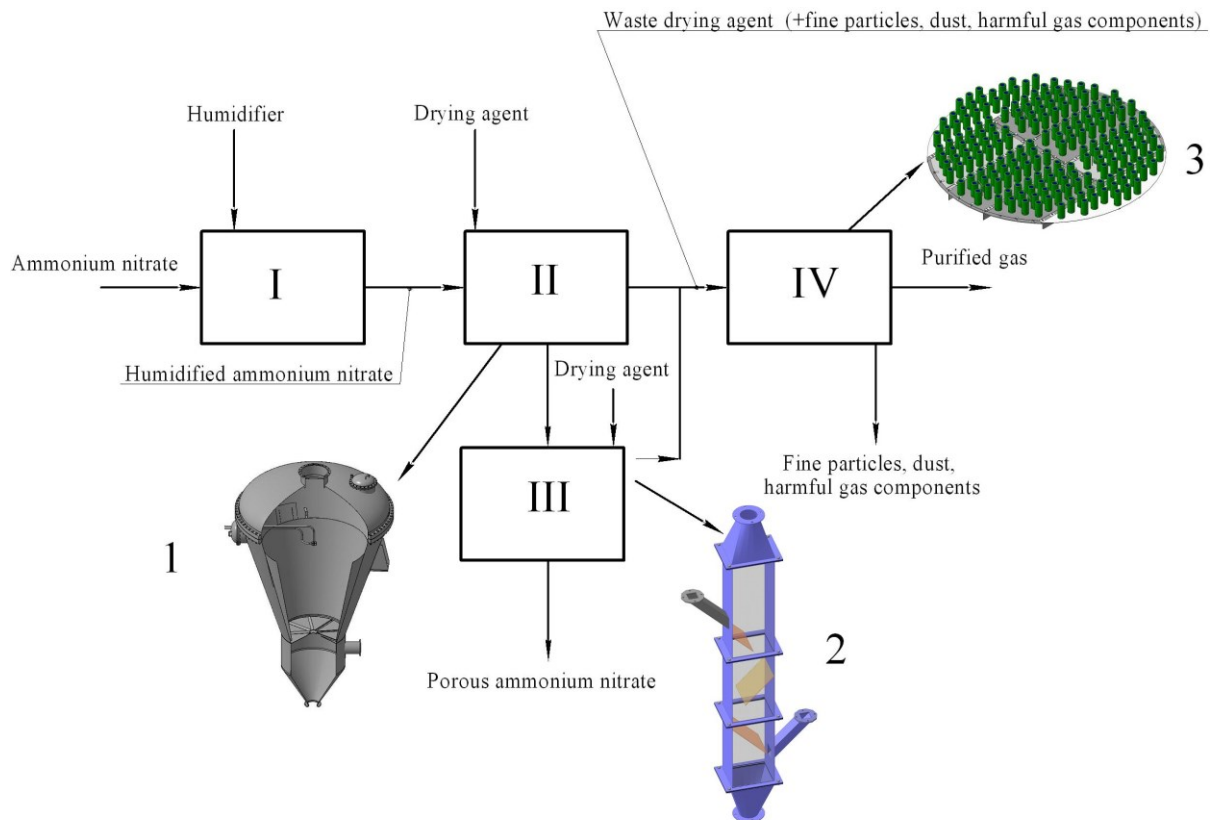

Figure 1. Diagram of porous ammonium nitrate production according to the method [15–18].

I - humidification of ordinary ammonium nitrate; II - heat treatment and drying of ordinary ammonium nitrate after humidification; III - final drying of PAN; IV - cleaning of exhaust gases; 1 - vortex granulator; 2 - multistage gravitational shelf dryer; 3 - contact tray with heat and mass transfer-separation elements.

In general, the algorithm to calculate the main technological equipment of the granulation unit to obtain PAN, can be presented as a scheme, shown in the figure 3. One or several software products, which together constitute an automated complex of the granulation unit calculation, correspond to each block of the scheme.

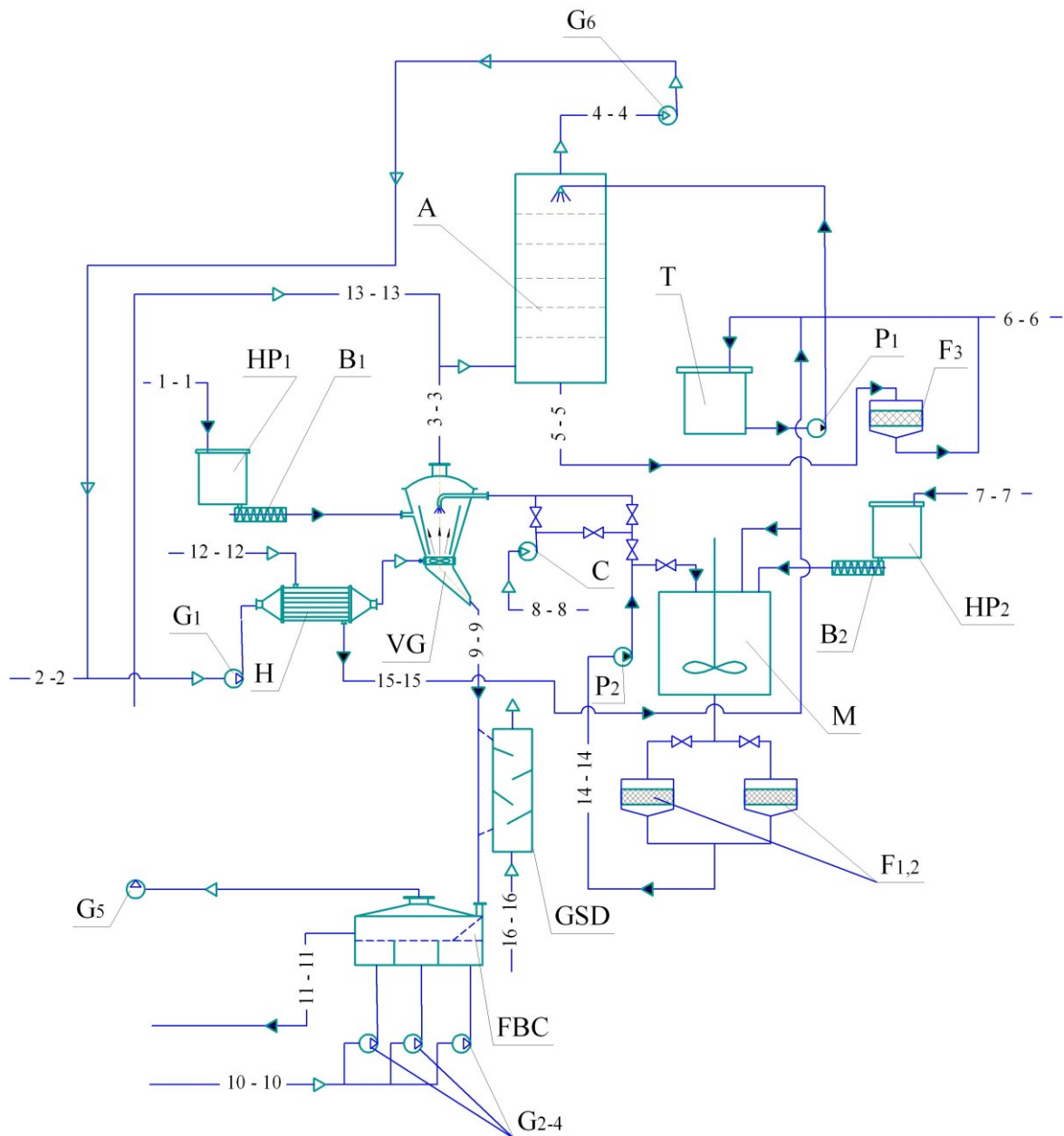

Figure 2. Technological scheme of the porous ammonium nitrate production.

Elements of the installation: VG - vortex granulator; H - heater; GHD - gravitational shelf dryer; FBC - fluidized bed cooler; A - absorber; F - filter; M - mixer; B - batcher; HP - hopper; G - gas blower; P - pump; T - tank; C - compressor. The main flows: 1-1 seeding agent; 2-2 manufacturing air; 3-3 polluted air; 4-4 purified air; 5-5 polluted water; 6-6 water; 7-7 substandard granules; 8-8 air for spraying of liquid material (solution, melt); 9-9 product; 10-10 air for cooling of granules; 11-11 granules for packaging; 12-12 steam; 13-13 dusty gas; 14-14 liquid material (solution, melt); 15-15 water condensate; 16-16 drying agent.

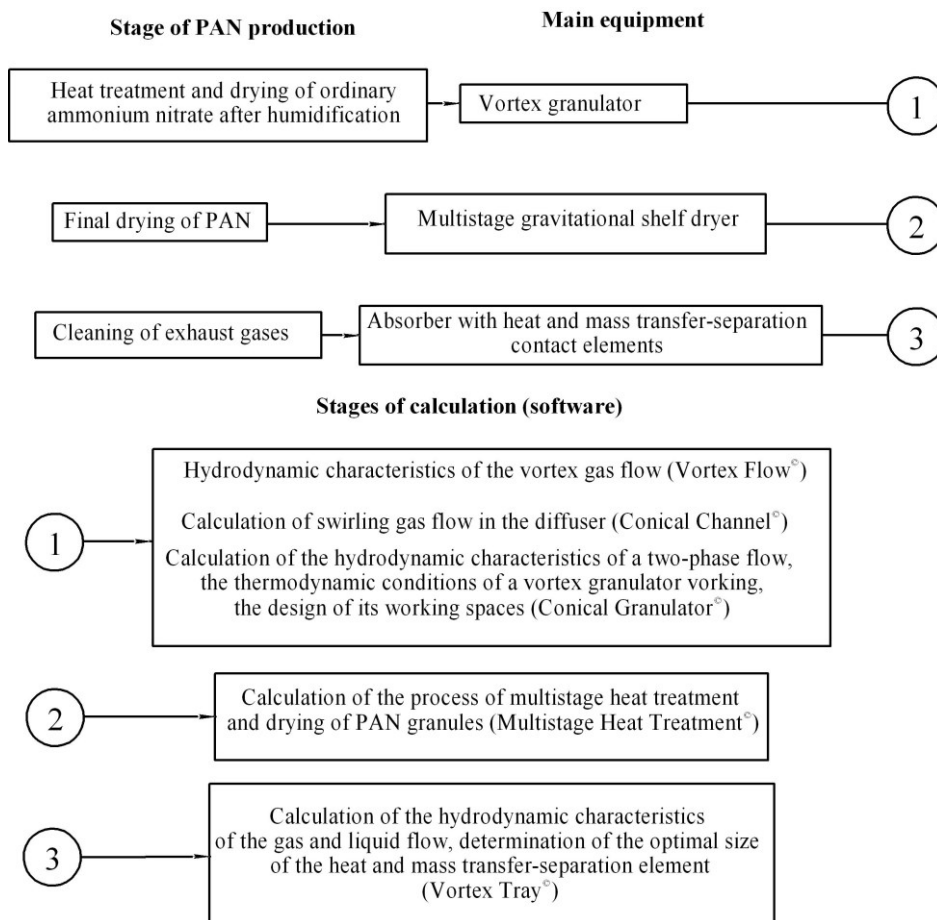

Figure 3. Algorithm of the main technological calculation of the PAN obtaining granulation unit.

Short description of the software products, which form automated complex of the granulation unit's calculation, is represented below.

3.1 Vortex Flow[®]

The program Vortex Flow[®] [23] (mathematic model, which is a basis of the software product, is shown in [24–26]) is for calculation of the hydrodynamic parameters of the twisted gas flow and particles, moving in it. It may be implemented in the hydrodynamic calculation of streams in the vortex heat and mass transfer (granulators, driers) and hydromechanical (classifiers, cyclones) equipment with variable cross sectional area of the workspace. The result of the calculation includes values of velocity's components of the gas flow and particles in the workspace of the device.

Having started the work with the program, one can see the dialog box on the screen of the computer. User inserts data for calculation into the corresponding fields in the dialog box. While setting basic data, user chooses the way to subdivide the workspace of the vortex device in the vertical and horizontal directions.

The next step is to output calculation results on the screen. The received data set is proposed to the user at the first stage (figure 4). Having carried out calculation, values set of the definite parameter in every computation grid cell appears on the screen according to their number in the basic data. Graphical dependences appear on the screen with right input of the basic data – figure 5.

3.2 Conical Channel[®]

The program Conical Channel[®] [27] (mathematic model, which is a basis of the software product, is shown in [28]) is for calculation of the axisymmetrical gas flows in channels, including twisted flows in diffusers.

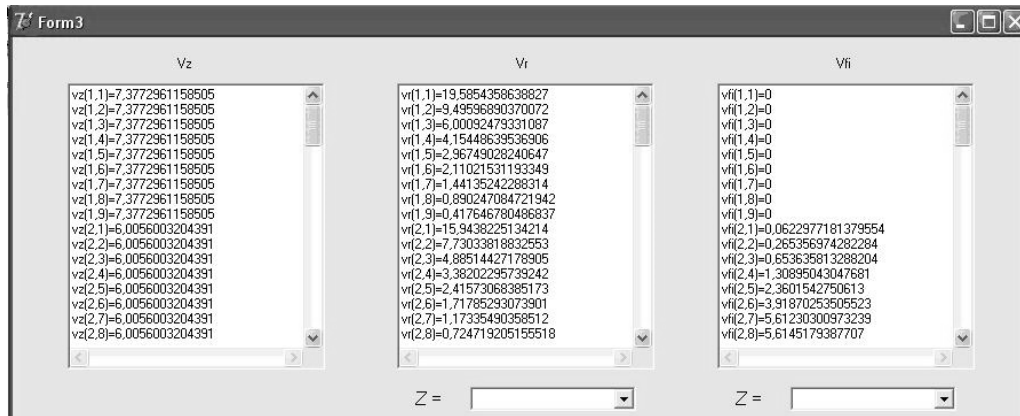

Figure 4. Computation data set (on the example of gas flow velocity calculation).

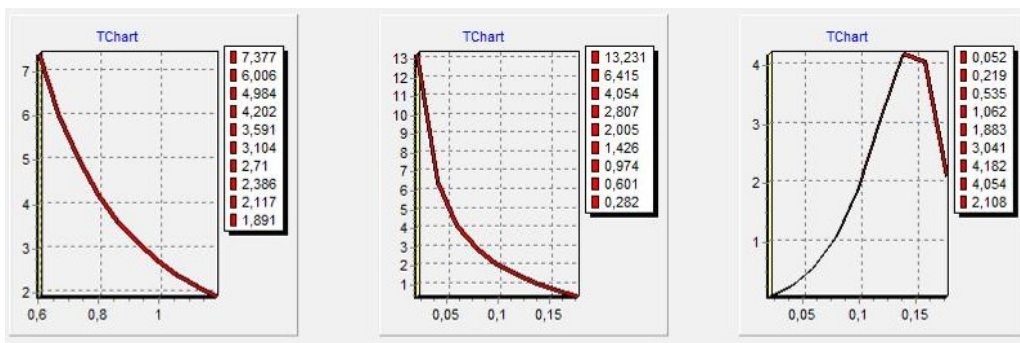

Figure 5. Output of graphical dependences (on the example of gas flow velocity calculation).

Mathematic model, which is a base of the investigated software product, includes so called generalized Prandtl equations (in Western terminology – Reduced Navier-Stokes Equations). Implementation of this mathematic model, realized in the curvilinear orthogonal coordinate system, enables rapidly and effectively to calculate streams per one pass from the inlet to the outlet cross-section of the calculation area.

The basic data for calculation include: geometric configuration of the channel, gas properties and parameters of the flow in the inlet cross-section. The task of calculation is to define velocity's fields and pressures in the whole calculation area and, consequently, to find size of energy loss between inlet and outlet cross-sections of the channel.

Having started the program, the dialog box is opened. The program starts its work from opening or creating of the new file of calculation area configuration. Example of the calculation area configuration is given in the figure 6.

After that, parameters, which have to be calculated (velocity components U , V , W or pressure P), are selected in the corresponding window. Having selected the necessary calculated parameter, the program forms computation grid (figure 7). Results of calculation are presented through graphic, which is shown in the figure 8.

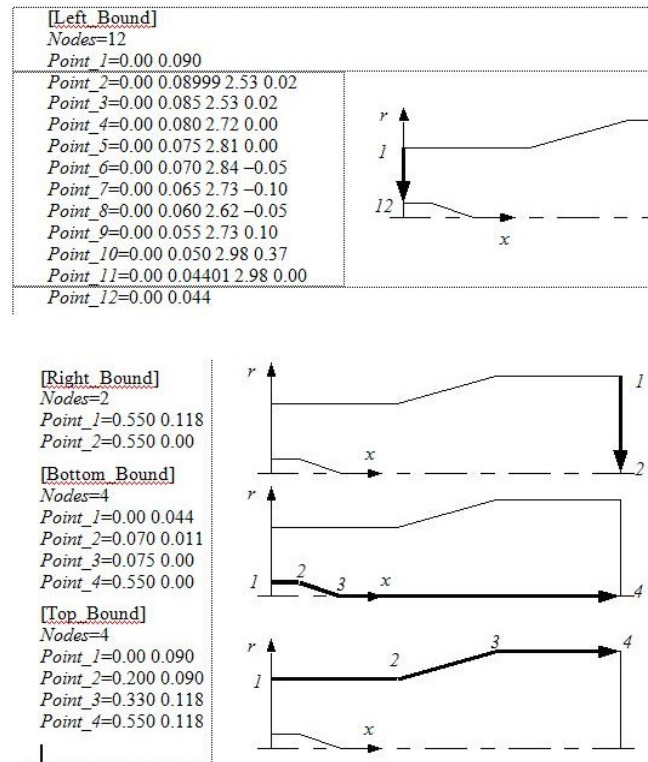

Figure 6. Example of calculation area configuration.

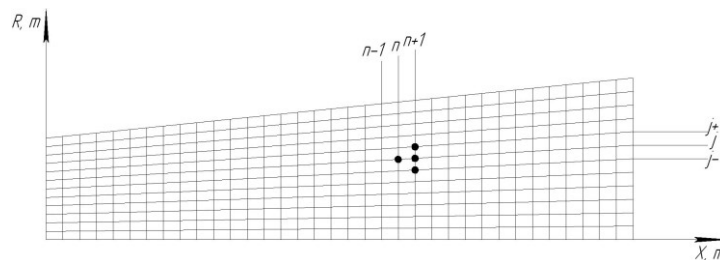

Figure 7. Formation of the computation grid.

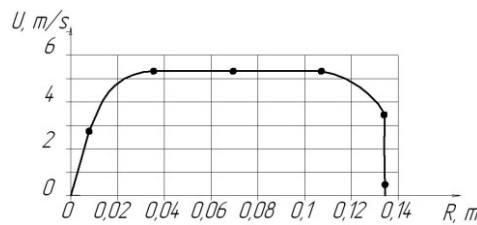

Figure 8. Results of calculation.

3.3 Conical Granulator[©]

The program Conical Granulator[©] [29] (mathematic model, which is a basis of the software product, is shown in [30–34]) is to calculate sizes of the variable cross sectional area of the vortex granulator’s workspace. The result of calculation is velocity of the granule’s levitation with definite physical and chemical properties, the way, which granule overcomes in the workspace of the vortex granulator and updated values of the main geometric sizes of the vortex granulator’s workspace by requirement of

providing the granule's levitation. The calculation is carried out for cylinder areas, into which granulator's conic space is divided, and calculations results at one area are basic data to calculate on the next stage on the granule's motion way.

Having seen the dialog box on the screen (figure 9) user inserts data into the proper fields for calculation. While inserting basic data, user selects individually the way to divide residence time of the particle in the granulator's workspace. The program outputs data of calculation as a list of results – figure 10.

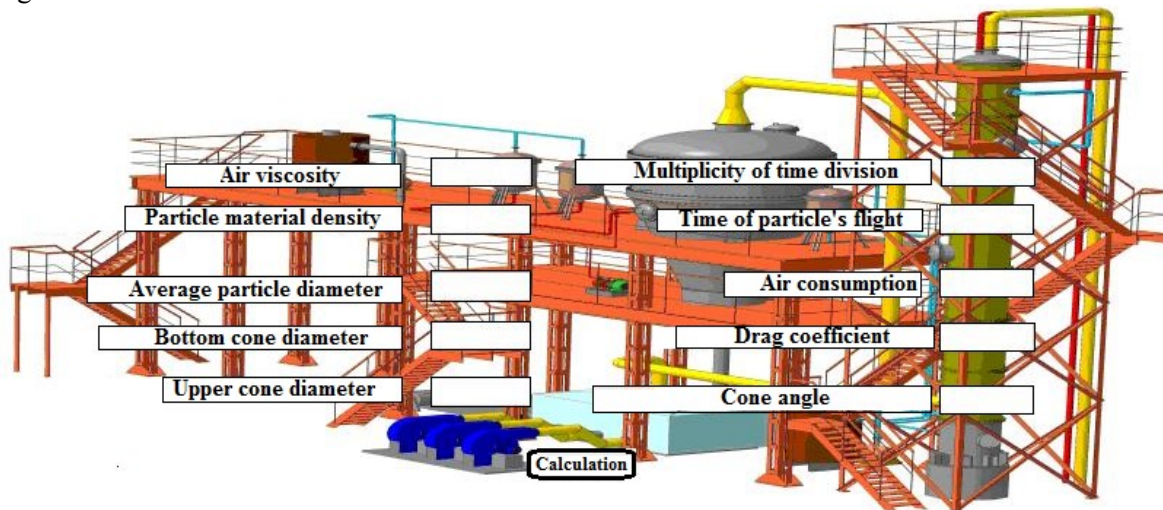

Figure 9. Dialog box of the program.

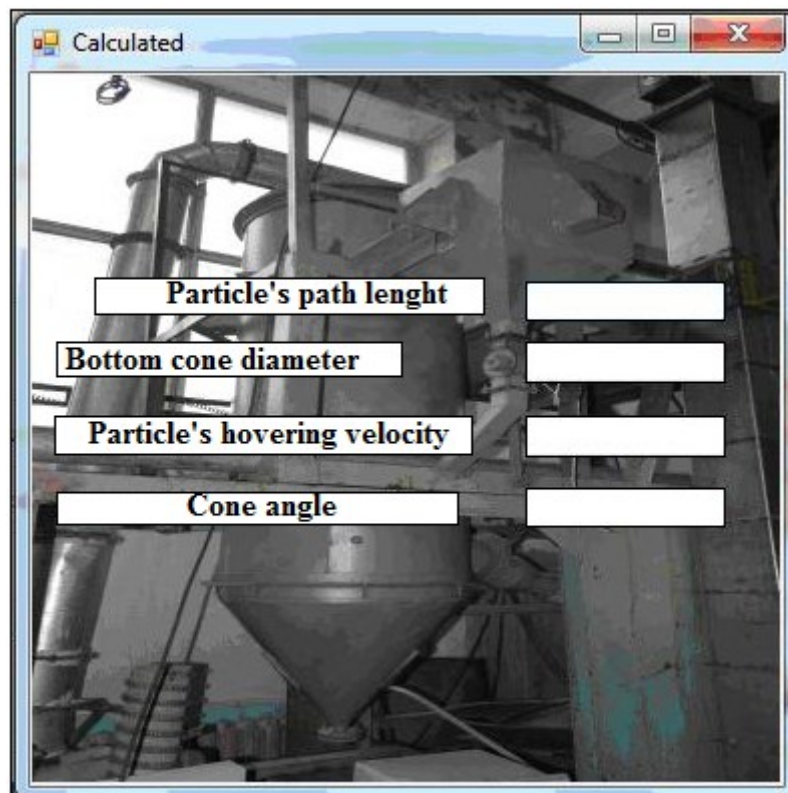

Figure 10. Results of calculation.

3.5 Vortex Tray[®]

The program Vortex Tray[®] [37] (mathematic model, which is a basis of the software product, is shown in [38, 39]) is to calculate optimal sizes of heat and mass transfer separation element of the vortex tray to clean exhaust gases and gas separation processes within technological units of chemical and gas-oil refinery plants. It may be used in the constructive calculation of the waste gases cleaner units of the weighted layer (granulators, dryers, coolers), and vortex trays as a part of column devices' mass transfer (absorption and rectification processes). The result of the calculation includes values of the vortex tray's heat and mass transfer-separation element's constructive parameters (diameter and height of fitting pipe) with variable hydrodynamic characteristics of liquid motion and its physical and chemical properties.

Having started the work with the program, start screen appears on the display (figure 15). In order to perform calculation, the user is provided with a list of boxes (figure 16), from which he selects necessary information for the research.

Having chosen the necessary box, user inserts data for calculation into the proper fields and displays the calculation results. While inserting the basic data, user chooses the way how to change parameter, which is varying.

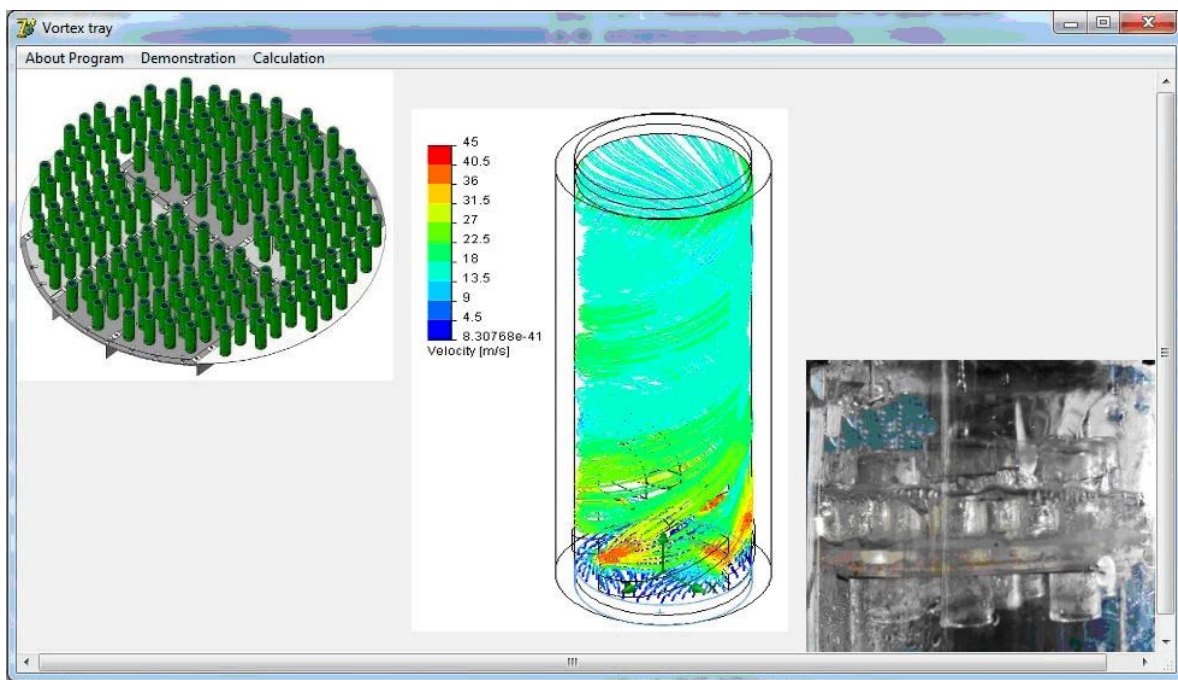

Figure 15. Start screen of the program.

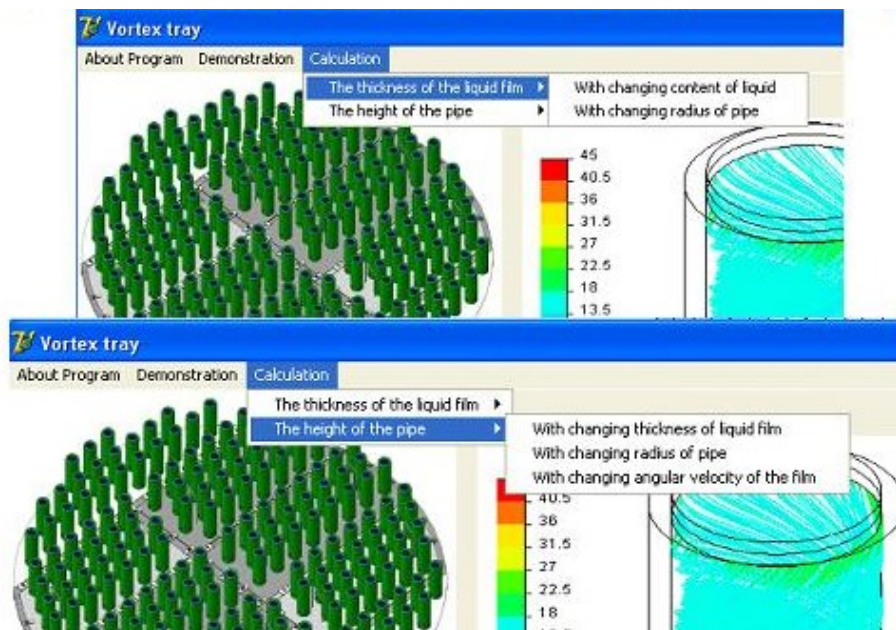

Figure 16. List of boxes for user's choice.

4. Conclusions and recommendations

The complex algorithm and software products, proposed in the article, enable to carry out optimization calculation of the main technological equipment in the granulation unit at its designing stage without an expensive multifactorial experiment. Besides, the granulation units' calculation algorithm and software products for algorithm implementation, observed in the article, let to changeover equipment if raw material characteristics and unit's productivity are changed.

The aim of further studies is to create exporting algorithm of constructive calculations results of the granulation unit's main technological equipment into the solid modeling programs with purpose to create device's models, and constructive and technological documentary for their production.

5. References

- [1] *Aspen HYSYS*® [Electronic resource] Access mode: <http://www.aspentech.com/products/aspens-hysys/>
- [2] *SimSci PRO/II* [Electronic resource] Access mode: <http://software.schneider-electric.com/products/simsci/design/pro-ii/>
- [3] *GasCondOil* [Electronic resource] Access mode: <http://thermogas.kiev.ua/Products.htm>
- [4] *ChemCAD* [Electronic resource] Access mode: <http://www.chemstations.com>
- [5] *DESIGN II* [Electronic resource] Access mode: <https://www.winsim.com/design.html>
- [6] *SIGMAFINE* [Electronic resource] Access mode: <https://sigmafine.pimsoftinc.com>
- [7] *gPROMS ModelBuilder* [Electronic resource] Access mode: <https://www.psenterprise.com/products/gproms>
- [8] *GIBBS* [Electronic resource] Access mode: <http://www.gibbsim.ru>
- [9] *ANSYS Fluent* [Electronic resource] Access mode: <http://www.ansys.com/Products/Fluids/ANSYS-Fluent>
- [10] *COSMOS FlowWorks* [Electronic resource] Access mode: <http://www.solidworks.com/sw/products/simulation/flow-simulation.htm>
- [11] *FlowVision* [Electronic resource] Access mode: <http://tesis.com.ru>
- [12] *Flow-3D CFD* [Electronic resource] Access mode: <https://www.flow3d.com>
- [13] *Ansys CFX* [Electronic resource] Access mode: <http://www.ansys.com/products/fluids/ansys-cfx>
- [14] *COMSOL Multiphysics* [Electronic resource] Access mode: <https://www.comsol.com>

- [15] Pat. No. 112294 UA 2016 Device for granulation in the suspended layer
- [16] Pat. No. 112393 UA 2016 Vortex granulator with utilization of waste gases
- [17] Pat. No. 112394 UA 2016 Vortex granulator
- [18] Pat. No. 112622 UA 2016 Vortex granulator
- [19] Pat. No. 113141 UA 2017 Vortex granulator
- [20] Artyukhov A 2016 *CEUR Workshop Proceedings* 1761 363–373
- [21] Artyukhov A, Sklabinskiy V, Ivaniiia A and Moskalenko K 2016 *CEUR Workshop Proceedings* **1761** 374–385
- [22] Artyukhov A E, Obodiak V K, Boiko P G and Rossi P C 2017 *CEUR Workshop Proceedings* **1844** 33–47
- [23] Certificate of authorship No. 52659 UA 2014. Computer program Vortex Flow[©]
- [24] Artyukhov A E and Sklabinskiy V I 2015 *Chemistry & chemical technology* **9** 175–180
- [25] Artyukhov A E, Fursa A S and Moskalenko K V 2015 *Chemical and Petroleum Engineering* **51** 311–318
- [26] Artyukhov A E and Sklabinskiy V I 2013 *Naukovyi Visnyk Natsionalnoho Hirnychoho Universytetu* **6** 42–48
- [27] Certificate of authorship No. 66782 UA 2016 Computer program Conical Channel[©]
- [28] Artyukhov A E and Sklabinskiy V I 2015 *Chemistry & chemical technology* **9** 337–342
- [29] Certificate of authorship No. 62692 UA 2015 Computer program Conical Granulator[©]
- [30] Artyukhov A E and Sklabinskiy V I 2016 *Journal of Nano- and Electronic Physics* **8** 04051
- [31] Artyukhov A E and Voznyi A A 2016 *6th International Conference Nanomaterials: Application & Properties (NAP-2016)* **5** 02NEA01
- [32] Artyukhov A E 2016 *6th International Conference Nanomaterials: Application & Properties (NAP-2016)* **5** 02NEA02
- [33] Artyukhov A E and Sklabinskiy V I 2016 *Journal of Nano- and Electronic Physics* **8** 04083
- [34] Artyukhov A E and Sklabinskiy V I 2017 *Journal of Nano- and Electronic Physics* **9** 01015
- [35] Certificate of authorship No. 57043 UA 2014. Computer program Multistage Heat Treatment[©]
- [36] Artyukhova N A, Shandyba A B and Artyukhov A E 2014 *Naukovyi Visnyk Natsionalnoho Hirnychoho Universytetu* **1** 92–98
- [37] Certificate of authorship No. 55360 UA 2014 Computer program Vortex Tray[©]
- [38] Artyukhov A E 2014 *Chemical and Petroleum Engineering* **49** 736–40
- [39] Prokopov M G, Levchenko D A and Artyukhov A E 2014 *Applied Mechanics and Materials* **630** 109–16

Acknowledgments

This research work had been supported by the Cultural and Educational Grant Agency of the Slovak Republic (KEGA), project No. KEGA 002TnUAD-4/2019 and by the Ministry of Science and Education of Ukraine under the project “Small-scale energy-saving modules with the use of multifunctional devices with intensive hydrodynamics for the production, modification and encapsulation of granules”, project No. 0119U100834.