

## Electrodeposition and Mechanical Characterization of Ni/SiC Composite Coatings

L. Ghelani<sup>1,2,\*</sup>, M. Naoun<sup>2,3</sup>, L. Aissani<sup>1</sup>, A. Abbassi<sup>2,3</sup>, S. Boulahrouz<sup>1</sup>

<sup>1</sup> Department of Mechanic, University Abbas Laghrour, 40000 Khenchela, Algeria

<sup>2</sup> Laboratory of Corrosion, Department of mechanic, University Mostefa Ben Boulaïd, Batna 2, 05000, Algeria

<sup>3</sup> Department of mechanic, University Mostafa Ben Boulaïd, Batna 2, 05000, Algeria

(Received 05 February 2019; revised manuscript received 10 June 2019; published online 25 June 2019)

The need to improve coatings for better properties leads to the development of composite electrolytic deposition, by adding insoluble solid particles to the electrolyte. These coatings typically contain ceramic particles in an electrodeposited matrix such as nickel. The aim of this work is to obtain an electrolytic nickel matrix (binder) with and without adding silicon carbide SiC microparticles (mean diameter 0.8  $\mu\text{m}$ ) which have a high hardness and a good chemical stability. The structural (Ni-SiC) composite and pure nickel coatings were prepared by electroplating deposition on steel in a Watts bath of electroplating chloride. The surface morphology, microstructure, and composition were studied by atomic force microscopy (AFM), nanoindentation, scanning electron microscopy (SEM) and X-ray diffractometer. The characterizations of the deposited layers are carried out in 3.5 % NaCl solution. The weight loss and the polarization results highlighted that the corrosion rate decreases with the increase of SiC concentration up to 15  $\text{gl}^{-1}$ . This decrease is probably due to the presence of SiC particles leading to improved corrosion resistance. These properties are mainly due to the homogeneous distribution of the constituents SiC as determined by AFM technique and the possibilities of combining the characteristics of base metals and their coatings. Moreover, the incorporation of the microparticles had a significant impact on the microhardness of the composite deposits Ni-SiC.

**Keywords:** Electroplating, Co-deposition, SiC, Weight loss, Polarization.

DOI: [10.21272/jnep.11\(3\).03016](https://doi.org/10.21272/jnep.11(3).03016)

PACS numbers: 68.37 – d, 68.37 – Ps, 81.65 – b, 81.65 – Cf

### 1. INTRODUCTION

Various techniques are applied for the realization of composite coatings such as PVD, CVD, ion implantation etc. [1, 2]. Composite coatings can also be obtained by deposition. This method also includes techniques for making deposits of material on the surface of the base materials from a bath loaded with suspended particles. Among these methods, electrodeposition is one of the efficient and cost-effective methods that can utilize a wide range of substrate sizes and reinforcements [3]. Most researchers use nickel as a matrix and ceramics as reinforcement [4]. The improvement of the process begins with the reliability of the methods of preparation of the surfaces allowing a good adhesion on the metal supports. Electrodeposition is considered one of the reliable techniques for producing composite deposits. Recently, a number of literature reports that SiC can be co-deposited to form composite coatings [5, 6]. Silicon carbide SiC is a ceramic compound that can be used in various scientific fields. The presence of these particles in the coating layers modifies mechanical properties such as resistance to corrosion, wear and micro-hardness. SiC is much more recommended for industrial applications [7]. These properties are mainly due to the strong covalent bond between silicon and carbon and for tetrahedral coordination. The first applications of coatings (Ni-SiC) have been appeared in the industry [8]. The development of these composite coatings leads to much better properties than materials made from simple coatings. This is probably due to the possibilities of combining the characteristics of the base materials and the composite coatings. In this study, we carried out various tests to determine the best SiC con-

centration in a nickel matrix. It concerns the realization of composite coatings Ni/SiC on steel substrate tested in 3.5 % NaCl solution. The results obtained show an improvement of the characteristics in particular behavior toward corrosion.

### 2. EXPERIMENTAL PROCEDURE

#### 2.1 Ni-SiC Composite Film Elaboration

The plating electrolyte used in this process was a nickel chloride bath. The composition and operating parameters for electroplating are shown in Table 1. The composite deposits were made by adding SiC to the electrolyte with concentrations varying from 5  $\text{gl}^{-1}$  to 30  $\text{gl}^{-1}$  in steps of 5  $\text{gl}^{-1}$ . A Ni plate and a steel substrate were used as anode and cathode, respectively (Fig. 1).

**Table 1** – Operating parameters for Ni-SiC composite electroplating

Deposition parameters	Amount
NiCl <sub>2</sub> -6H <sub>2</sub> O	11.885 $\text{gl}^{-1}$
NH <sub>4</sub> Cl	12.303 $\text{gl}^{-1}$
NaCl	4.091 $\text{gl}^{-1}$
H <sub>3</sub> BO <sub>3</sub>	6.183 $\text{gl}^{-1}$
SiC	5-30 $\text{gl}^{-1}$
pH	4.5 $\pm$ 0.1
Temperature	45 $\pm$ 1 $^{\circ}\text{C}$
Electrical intensity	60 mA
Stirring speed	250 rpm
Plating time	60 mn

\* [ghilani@yahoofr](mailto:ghilani@yahoofr)

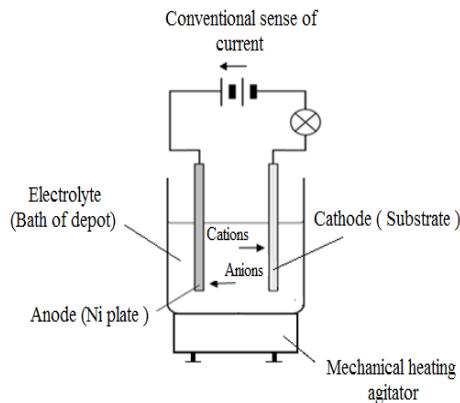

**Fig. 1** – Experimental device for electrolytic nickel plating

The bath temperature was 45 °C and the intensity was 60 mA. The pH was adjusted to  $4.5 \pm 0.1$ . After the addition of SiC particles to the electrolyte, particle repartition was carried by a magnetic stirrer. The deposition time was 60 nm. The steel chemical composition, determined by X-ray diffraction, is shown in Table 2. Two series of samples were obtained by varying the SiC particle content. Cylindrical 6 mm diameter and 60 mm length pieces were used for immersion and potentiostatic tests and rectangular pieces (1.8×20×25 mm) were utilized for micrographic examinations.

The substrates were pickled in nitric acid bath diluted for 5 min and polished to 0.09 mm surface roughness. They were then rinsed with distilled water [9, 10].

**Table 2** – Steel chemical composition

XC45	C	Si	Mn	S, P	Cr	Cu	Ni
wt. %	0.46	0.27	0.6	S < 0.035	0.25	0.25	0.2

## 2.2 Co-deposition

The principle of electrolytic co-deposition rests on the possibility of incorporating into electrolytic deposits (or catalysts) solid particles held in suspension in the electrolytic bath. The degree of incorporation is a function of the current intensity, the particles concentration in the bath and the mass transport along the cathode. Electrolytic co-deposition in our work is the incorporation of solid SiC particles in the cathodic deposit. During the electrolysis, these particles are incorporated into the metal deposit obtained at the cathode followed by the reduction of the metal ions present in the electrolysis bath. The composite deposit mechanism is schematized in Fig. 2.

## 2.3 Degassing

The degassing heat treatment is carried out at 180 °C for one hour in order to eliminate the brittleness of the coated parts due to the presence of hydrogen trapped in the defects during the various treatments of the sample (mechanical or thermal).

## 2.4 Ni/SiC Coating Characterization

The behavior of composite Ni-SiC coatings for different concentrations of SiC on steel substrates toward corrosion in 3.5 % NaCl solution was determined by the

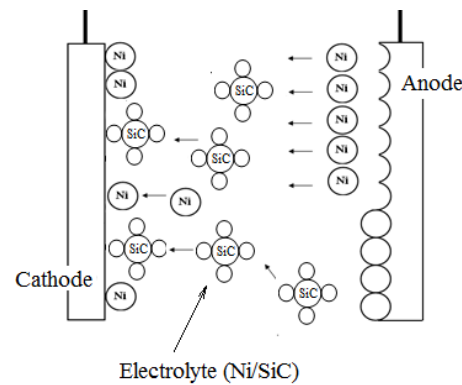

**Fig. 2** – Co-deposition process

following methods.

### 1. Weight loss

The aim of this method is to measure the mass loss of each specimen after a 15 day immersion in a corrosive medium (3.5 % NaCl) with the presence of different concentrations of SiC. The specimens are weighed on an analytical scale of the type OHAUS AR 125CN. Following immersion, the specimens were reweighed after surface cleaning which removes any corrosion deposition from the surface. They were then, rinsed with distilled water and drying.

### 2. Electrochemical polarization

The polarization tests were carried out in distilled water electrolyte containing 3.5 % NaCl, with a Potentiostat Voltalab PGP 201 and a three-electrode cell; the working electrode, a platinum counter electrode and a saturated calomel reference electrode. The scanning rate was  $10 \text{ mV} \cdot \text{min}^{-1}$ .

### 3. Microhardness tests

The Vickers hardness ( $H_v$ ) measurements were carried out on samples cut into the shape of a prism. These tests used an analytical microdurometer of type AFFRI 1-21056 INDULODONA. Due to the relatively low thickness of the deposited layers we chose a load  $F = 1 \text{ kN}$  and 15 s penetration time.

The values of the microhardness were determined by the following formula [11]:

$$H_v = \frac{1.854F}{d^2}, \quad (1)$$

where  $H_v$  is the Vickers hardness ( $\text{kN} \cdot \text{mm}^{-2}$ ),  $F$  is a test load (kN),  $d$  is an average of the diagonals of the impression ( $d_1$  and  $d_2$ ) (mm), and

$$d = \frac{d_1 + d_2}{2}. \quad (2)$$

### 4. Analysis by Atomic Force Microscopy (AFM)

The microscope used is AFM 100 APE research Nanotechnology multimode. We applied the contact mode for good lateral imaging resolution. This allowed to show the very fine variations of the morphology.

### 5. Scanning electron microscopy (SEM) analysis

The surface morphologies of the deposits were characterized using a JEOL JSM 5900 LV scanning electron microscope coupled to the Oxford Energy Incompatible Spectrometer (INCA X-act).

### 3. RESULTS AND DISCUSSION

#### 3.1 Influence of SiC Concentration on Corrosion Behavior of Coated XC45 Steel

##### 3.1.1. Weight Loss Testing

The results are presented in Fig. 3.

Based on the results obtained, we note that the corrosion rate decreases with the increase of SiC concentration up to  $15 \text{ gl}^{-1}$ . This decrease is due to the presence of the SiC particles (known for its improved physical and chemical properties in the coating layers leading to the improvement of the corrosion resistance. These properties are mainly due to the very solid covalent bond between silicon and carbon as well as for tetrahedral coordination. The homogeneity of the distribution of constituents (SiC) is determined by AFM and the possibilities of combining the characteristics of base metals and their coatings. Following the observation of the samples after immersion in the electrolyte (pH 2.5) and according to the nature of the nickel coating on the steel (cathodic coating), we note that for SiC concentrations above  $20 \text{ gl}^{-1}$ , the surface corrosion is pitting corrosion (the number of pits increases with the increase in SiC content). This is probably due to the creation of microcells on the surface of the substrate resulting from the heterogeneity in the deposit, on the one hand, and the presence of pure Ni in the coating and the formation of galvanic cells, on the other hand.

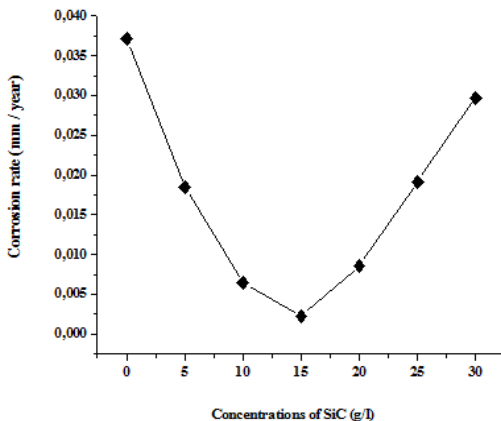

Fig. 3 – Corrosion rate of the specimens as a function of different SiC concentrations

##### 3.1.2. Polarization Curves

The current/voltage curves were obtained by performing a potential sweep from  $-850 \text{ mV/SCE}$  up to  $+850 \text{ mV/SCE}$ . Corrosion currents were obtained for different concentrations of SiC (see Fig. 4).

According to the results obtained we note a gradual decrease in the corrosion rate estimated as a function of the increase in the concentration of silicon carbide added up to the concentration of  $15 \text{ gl}^{-1}$ . And beyond this latter, the corrosion rate increases with the increase of SiC concentrations. The corrosion rate variations have the same appearance as those obtained by the weight loss technique.

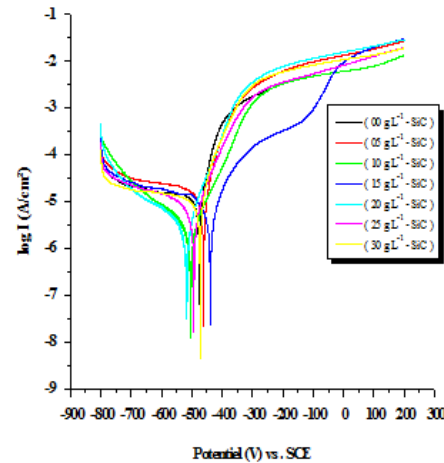

Fig. 4 – Polarization curves of composite deposits Ni/SiC in a 3.5 % NaCl solution (pH 4.5)

##### 3.2 Microhardness Measurement

The values given are the average hardness obtained with a minimum of 5 tests for each load and each deposit. The microhardness tests carried out show in all cases a slight increase in the hardness of the deposits with the increase in SiC content of the bath. These results are in close agreement with the theory that predicts the increase in hardness with the increase in SiC content (Table 3).

Table 3 – Vickers microhardness of different Ni/SiC composite deposits

SiC concentration, $\text{gl}^{-1}$	$d_1$ , $\mu\text{m}$	$d_2$ , $\mu\text{m}$	$D$ , $\mu\text{m}$	Vickers microhardness
0	89.3	85.7	87.5	242.16
5	86.4	82.8	84.6	259.04
10	85.4	82.5	83.9	263.07
15	88.5	75.3	81.9	276.40
20	81.2	81.8	81.5	279.12
25	80.0	80.2	80.1	288.96
30	78.5	80.9	79.7	291.87

##### 3.3 Atomic Force Microscopy (AFM) Observations

Using AFM analysis to analyze the composite deposits Ni-SiC, we observe a significant evolution of the deposit morphology as a function of the introduction of SiC. The deposits without SiC particles exhibit a very smooth morphology with rare nodules (Fig. 5a). As the silicon carbide content increases, the deposits become rough and the number of nodules increases. We also observe a microstructural refinement of the deposits as a function of the increase in the content of silicon carbide. The images clearly show SiC particles with conical heads (shiny points) embedded in the nickel matrix (Fig. 5b-d).

##### 3.4 Scanning Electron Microscopy (SEM) Observations

The results of the SEM analysis of Ni/SiC composites are presented in the figures below.

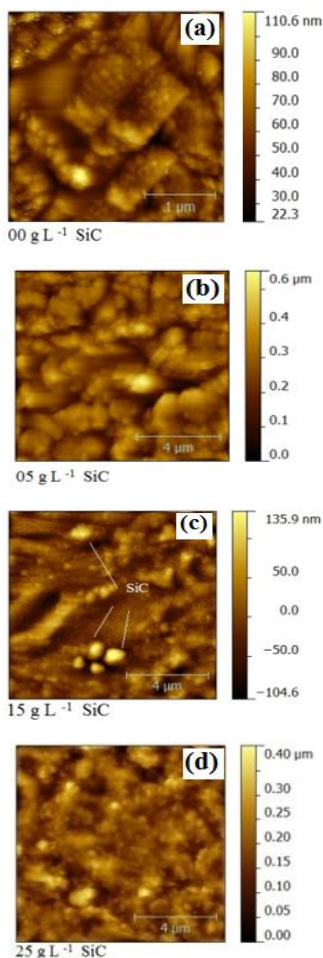

**Fig. 5** – AFM image of Ni-SiC composite coatings for different concentrations of SiC

The micrograph (SEM) illustrated in Fig. 6 shows that Ni-SiC deposition is not homogeneous; we clearly notice empty sites in the form of small crevices formed directly on the steel substrate. In the presence of aggressive ions, such as chlorides, these crevices can be developed into micro-bites thus creating a galvanic corrosion stack between the steel (anode) and the Ni-SiC composite coating (cathode). EDS analysis of the spectra, Fig. 6b, shows a matrix essentially made of nickel; we note the presence of oxygen and iron revealing the existence of iron oxides formed during electroplating. The chlorine resulting from the deposition bath is also present. Carbon and silicon are also present in small quantities.

According to Fig. 7, with the presence of 25  $\text{gl}^{-1}$  of SiC in the coating bath, it can be seen that the deposit structure is granular, the presence of cracks and pores is also observed, these surface irregularities can facilitate the intrusion of aggressive ions such as chloride ions and therefore, the corrosion rate of the steel substrate is accelerated beyond 15  $\text{gl}^{-1}$  of SiC.

#### 4. CONCLUSIONS

- According to the results obtained by weight loss and electrochemical polarization techniques, we notice that the corrosion rate decreases with the increase in SiC concentration up to 15  $\text{gl}^{-1}$ . This decrease is

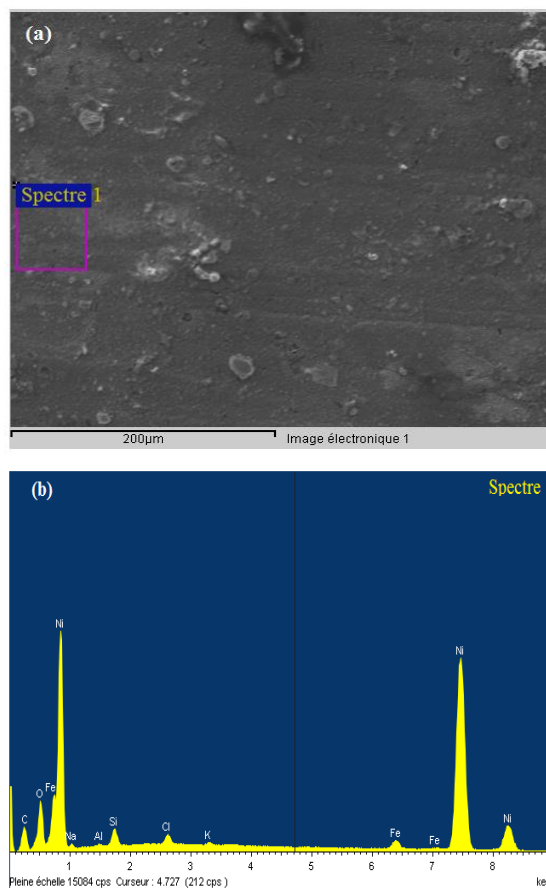

**Fig. 6** – SEM image and EDS surface morphology of Ni-SiC composite deposit in the presence of 10 g/l of SiC

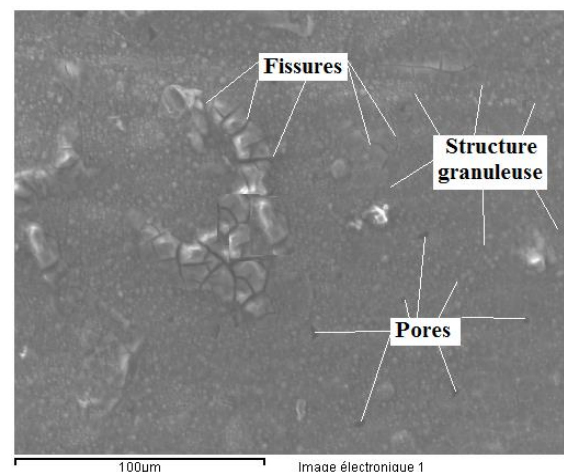

**Fig. 7** – Surface morphology of N/SiC composite deposit in the presence of 25 g/l of SiC

probably due to the presence of SiC particles leading to improved corrosion resistance. These properties are mainly due to the homogeneous distribution of the constituents (SiC) as determined by the atomic force microscopy technique and the possibilities of combining the characteristics of base metals and their coatings. However, optical observations highlight that for SiC concentrations above 20  $\text{gl}^{-1}$ , the form of corrosion encountered in these cases is pitting corrosion (the number of pits increases with the increase in SiC content). The results of local attacks

of the passive film due to the presence of the micro-cells on the substrate surface may result from the excess of SiC causing heterogeneity in the deposit.

- AFM analysis of Ni-SiC composite deposits shows a significant evolution of deposit morphology as a function of SiC introduction. Deposits without SiC particles have a very smooth morphology with rare nodules. As the silicon carbide content increases, the deposits become rough and the number of nodules increases randomly with various dimensions. We also observe a microstructural refinement of the deposits as a function of the increase in the silicon carbide content.

- The SEM micrograph of Ni-SiC composite deposit shows a more compact and homogeneous deposition for concentrations below 15  $\text{gl}^{-1}$  SiC and with silicon carbide content above 15  $\text{gl}^{-1}$ ; it can be seen that the deposit structure is granular, the presence of cracks and pores is also canceled, the surface irregularities can be the intrusion of aggressive ions such as chloride ions.

#### ACKNOWLEDGEMENTS

The authors want to thank especially prof. Abbassi A. for his advices and collaboration during this work.

#### REFERENCES

1. P. Gyftou, E.A. Pavlatou, N. Spyrellis, *Appl. Surf. Sci.* **254**, 5910 (2008).
2. A.D. Pogrebnyak, Sh.M. Ruzimov, D.L. Alontseva, P. Zukowski, C. Karwat, C. Kozak, M. Kolasik, *Vacuum* **81**, 1243 (2007).
3. Y. Zhou, H. Zhang, B. Qian, *Appl. Surf. Sci.* **253**, 8335 (2007).
4. S. Xie, X.L. Tong, G.Q. Jin, Y. Qin, X.Y. Guo, *J. Mater. Chem. A* **1** 2104 (2013).
5. Zh. Zengwei, Zh. Di, Q. Ningsong, L. Weining, *Mater. Des.* **28** 1776 (2007).
6. Z. Wang, J. Shemilt, P. Xiao, *Scr. Mater.* **42**, 653 (2000).
7. E.A. Pavlatou, M. Stroumbouli, P. Gyftou, N. Spyrellis, *J. Appl. Electrochem.* **36**, 385 (2006).
8. M.J. Jiao, X.X. Wang, *Mater. Lett.* **63**, 2286 (2009).
9. Y. Wang, H.B. Xu, *Res. J. Appl. Sci. Eng. Technol.* **24**, 5602 (2013).
10. M. Wery, *Décapage des Métaux*, M1455 (Technique de l'Ingénieur: 2000).
11. J.X. Kang, W.Z. Zhao, G.F. Zhang, *Surf. Coat. Technol.* **203**, 1815 (2009).

### Електроосадження та механічні характеристики композитних покриттів Ni/SiC

L. Ghelani<sup>1,2</sup>, M. Naoun<sup>2,3</sup>, L. Aissani<sup>1</sup>, A. Abbassi<sup>2,3</sup>, S. Boulahrouz<sup>1</sup>

<sup>1</sup> *Department of Mechanic, University Abbas Laghrour, 40000 Khenchela, Algeria*

<sup>2</sup> *Laboratory of Corrosion, Department of mechanic, University Mostefa Ben Boulaïd, Batna 2, 05000, Algeria*

<sup>3</sup> *Department of mechanic, University Mostafa Ben Boulaïd, Batna 2, 05000, Algeria*

Необхідність вдосконалення покриттів для поліпшення їх властивостей призводить до розробки композитного електролітичного осадження шляхом додавання до електроліту нерозчинних твердих частинок. Ці покриття зазвичай містять керамічні частинки в електроосадженій матриці, такі як нікель. Метою даної роботи є отримання електролітичної нікелевої матриці (з'єднувальної) із та без додавання мікрочастинок карбиду кремнію SiC (середній діаметр 0.8 мкм), які мають високу твердість і гарну хімічну стабільність. Структурні (Ni-SiC) композитні і чисті нікелеві покриття готували шляхом нанесення гальванопластики на сталь у ванні Ваттса з гальванічним хлоридом. Вивчено морфологію поверхні, мікроструктуру та склад отриманих покриттів методом атомно-силової мікроскопії (AFM), наноіндентації, скануючої електронної мікроскопії (SEM) та рентгенівського дифрактометра. Характеристики нанесених шарів проводять у 3.5 % розчині NaCl. Втрата ваги та результати поляризації підкреслили, що швидкість корозії зменшується зі збільшенням концентрації SiC до 15  $\text{gl}^{-1}$ . Це зменшення, ймовірно, пояснюється присутністю частинок SiC, що призводять до поліпшення корозійної стійкості. Ці властивості в основному обумовлені однорідним розподілом складових SiC, визначеним методом АСМ, та можливостями поєднання характеристик основних металів та їх покриттів. Більш того, включення мікрочастинок мало значний вплив на мікротвердість композитних нанесень Ni-SiC.

**Ключові слова:** Гальванічне покриття, Спільне осадження, SiC, Втрата ваги, Поляризація.